

February 14, 2023

Wisconsin Department of Natural Resources

Mr. Peter Raymond  
1300 W. Clairmont Avenue  
Eau Claire, WI 54701



**Subject:**

Post Closure Modification Notification  
Reconstruction of Utilities and Streets  
2<sup>nd</sup> Street, 3<sup>rd</sup> Street and Jackson Street  
Wausau Center Mall – Former  
301 Washington Street, Wausau, WI  
BRRTS#03-37-587769

**Dear Peter:**

The above referenced site was closed by the WDNR on April 7, 2022, with continuing obligations. The case closure letter from WDNR included as Attachment A noted the following:

- Soil contamination remains on the property. If soil in the location(s) identified is excavated in the future, the property owner or right of way holder at the time of excavation must sample and analyze the excavated soil. If sampling confirms that contamination is present, the property owner or right of way holder at the time of excavation will need to determine if the material is considered solid waste and ensure that any storage, treatment or disposal complies with applicable standards and rules. Contaminated soil may be managed under Wis. Admin. Code ch. NR 718. In addition, all current and future property owners, occupants and right of way holders need to be aware that excavation of the contaminated soil may pose an inhalation and direct contact hazard; special precautions may be needed to prevent a threat to human health.
- The site was closed with a barrier or cover. This impervious barrier shall be maintained in compliance with the enclosed maintenance plan, dated December 28, 2021. The purpose of the cover is to minimize the infiltration of water through contaminated soil and prevent direct contact with residual soil contamination that might otherwise pose a threat to human health

The closure letter required notification to the WDNR for any proposed changes to the barrier or cover. REI engineering, Inc. (REI) on behalf of the City of Wausau (City) is notifying WDNR that there is an intent to make changes to the property. Specifically, the City of Wausau will be reestablishing 2<sup>nd</sup> Street, 3<sup>rd</sup> Street, and Jackson Street as this property has been dedicated to the City upon recording of the Alexander Davis Plat. The plat map included as Attachment B reveals the Lots of the former parcel as well as proposed streets which were dedicated to the public.

Attachment C is a rendering from the City's engineer, Becher Hoppe Associates, Inc. (Becher Hoppe) which is a 30% complete rendering showing the phases of the development along with the schedule



**RESPONSIVE. EFFICIENT. INNOVATIVE.**

4080 N. 20th Avenue Wausau, WI 54401  
715-675-9784 REIengineering.com

for reconstruction of utilities and streets. WOZ, Inc. is working with a construction company to remove the concrete surface of the former mall in Lot 4 and a portion of Lot 5 along with 2<sup>nd</sup> Street, 3<sup>rd</sup> Street, and Jackson Street. Construction start date will be on or after March 27, 2023.

After the concrete cap is removed, street utility work will be completed for the re-establishment of 2<sup>nd</sup>, 3<sup>rd</sup> and Jackson streets.

Attachment D identifies the areas for proposed removal of concrete cap for the Lot 3, 4, 6, and street redevelopment. Once the redevelopment of Streets is completed, there will be updated documentation including cap maintenance plans for the City of Wausau. REI will conduct oversight of the management of impacted soils. Sampling will be completed to verify soil conditions. Impacted soil that does not remain on the property will be transported to the Marathon County solid waste landfill.

Attachment E is the soil erosion control plan mapping completed by Becher Hoppe for the City of Wausau.

Once the site work is completed, REI will provide a post construction documentation report including soil management and updated cover conditions. Thank you for your assistance and please contact REI with any questions you may have at (715) 675-9784 or [klassa@reiengineering.com](mailto:klassa@reiengineering.com)

Sincerely,  
REI Engineering, Inc.



Ken Lassa, P.S.  
Senior Consultant/Vice President

#### Attachments

cc: City of Wausau, Mr. Eric Lindman (e-copy)  
WOZ, Inc., Mr. Chuck Ghidorzi (e-copy)

**Notice:** Use this form to request a **written response (on agency letterhead)** from the Department of Natural Resources (DNR) regarding technical assistance, a post-closure change to a site, a specialized agreement or liability clarification for Property with known or suspected environmental contamination. A fee will be required as is authorized by s. 292.55, Wis. Stats., and NR 749, Wis. Adm. Code., unless noted in the instructions below. Personal information collected will be used for administrative purposes and may be provided to requesters to the extent required by Wisconsin's Open Records law [ss. 19.31 - 19.39, Wis. Stats.].

## Definitions

**"Property"** refers to the subject Property that is perceived to have been or has been impacted by the discharge of hazardous substances.

**"Liability Clarification"** refers to a written determination by the Department provided in response to a request made on this form. The response clarifies whether a person is or may become liable for the environmental contamination of a Property, as provided in s. 292.55, Wis. Stats.

**"Technical Assistance"** refers to the Department's assistance or comments on the planning and implementation of an environmental investigation or environmental cleanup on a Property in response to a request made on this form as provided in s. 292.55, Wis. Stats.

**"Post-closure modification"** refers to changes to Property boundaries and/or continuing obligations for Properties or sites that received closure letters for which continuing obligations have been applied or where contamination remains. Many, but not all, of these sites are included on the GIS Registry layer of RR Sites Map to provide public notice of residual contamination and continuing obligations.

## Select the Correct Form

This form should be used to request the following from the DNR:

- Technical Assistance
- Liability Clarification
- Post-Closure Modifications
- Specialized Agreements (tax cancellation, negotiated agreements, etc.)

**Do not use this form if one of the following applies:**

- Request for an **off-site liability exemption or clarification** for Property that has been or is perceived to be contaminated by one or more hazardous substances that originated on another Property containing the source of the contamination. Use DNR's Off-Site Liability Exemption and Liability Clarification Application Form 4400-201.
- Submittal of an Environmental Assessment for the **Lender Liability Exemption**, s 292.21, Wis. Stats., **if no response or review by DNR is requested**. Use the Lender Liability Exemption Environmental Assessment Tracking Form 4400-196.
- Request for an **exemption to develop on a historic fill site** or licensed landfill. Use DNR's Form 4400-226 or 4400-226A.
- **Request for closure** for Property where the investigation and cleanup actions are completed. Use DNR's Case Closure - GIS Registry Form 4400-202.

**All forms, publications and additional information are available on the internet at:** [dnr.wi.gov/topic/Brownfields/Pubs.html](http://dnr.wi.gov/topic/Brownfields/Pubs.html).

## Instructions

1. Complete sections 1, 2, 6 and 7 for all requests. Be sure to provide adequate and complete information.
2. Select the type of assistance requested: Section 3 for technical assistance or post-closure modifications, Section 4 for a written determination or clarification of environmental liabilities; or Section 5 for a specialized agreement.
3. Include the fee payment that is listed in Section 3, 4, or 5, unless you are a "Voluntary Party" enrolled in the Voluntary Party Liability Exemption Program **and** the questions in Section 2 direct otherwise. Information on to whom and where to send the fee is found in Section 8 of this form.
4. Send the completed request, supporting materials and the fee to the appropriate DNR regional office where the Property is located. See the map on the last page of this form. A paper copy of the signed form and all reports and supporting materials shall be sent with an electronic copy of the form and supporting materials on a compact disk. For electronic document submittal requirements see: <http://dnr.wi.gov/files/PDF/pubs/rr/RR690.pdf>

The time required for DNR's determination varies depending on the complexity of the site, and the clarity and completeness of the request and supporting documentation.

# Technical Assistance, Environmental Liability Clarification or Post-Closure Modification Request

Form 4400-237 (R 12/18)

Page 2 of 7

## Section 1. Contact and Recipient Information

### Requester Information

This is the person requesting technical assistance or a post-closure modification review, that his or her liability be clarified or a specialized agreement and is identified as the requester in Section 7. DNR will address its response letter to this person.

Last Name Eric	First Lindman	MI	Organization/ Business Name City of Wausau
Mailing Address 407 Grant Street			City Wausau
			State WI
			ZIP Code 54403-4783
Phone # (include area code) (715) 261-6745	Fax # (include area code)	Email Eric.Lindman@ci.wausau.wi.us	

The requester listed above: (select all that apply)

- Is currently the owner
  Is considering selling the Property  
 Is renting or leasing the Property
  Is considering acquiring the Property  
 Is a lender with a mortgagee interest in the Property  
 Other. Explain the status of the Property with respect to the applicant:

### Contact Information (to be contacted with questions about this request)

Select if same as requester

Contact Last Name Eric	First Lindman	MI	Organization/ Business Name City of Wausau
Mailing Address 407 Grant Street			City Wausau
			State WI
			ZIP Code 54403-4783
Phone # (include area code) (715) 261-6745	Fax # (include area code)	Email Eric.Lindman@ci.wausau.wi.us	

### Environmental Consultant (if applicable)

Contact Last Name Lassa	First Kenneth	MI J	Organization/ Business Name REI Engineering, Inc.
Mailing Address 4080 N. 20th Avenue			City Wausau
			State WI
			ZIP Code 54401
Phone # (include area code) (715) 675-9784	Fax # (include area code) (715) 675-4060	Email klassa@reiengineering.com	

## Section 2. Property Information

Property Name Wausau Center Mall - Former	FID No. (if known) 737053460
BRRTS No. (if known) 02-37-587769	Parcel Identification Number Land dedicated to City for 2nd Street, 3rd Street and Jackson Streets
Street Address 301 Washington Street	City Wausau
County Marathon	Municipality where the Property is located <input checked="" type="radio"/> City <input type="radio"/> Town <input type="radio"/> Village of Wausau
Property is composed of: <input checked="" type="radio"/> Single tax parcel <input type="radio"/> Multiple tax parcels	
Property Size Acres	

# Technical Assistance, Environmental Liability Clarification or Post-Closure Modification Request

Form 4400-237 (R 12/18)

Page 3 of 7

1. Is a response needed by a specific date? (e.g., Property closing date) Note: Most requests are completed within 60 days. Please plan accordingly.

No  Yes

Date requested by: 03/27/2023

Reason: WOZ, Inc. is planning to remove concrete surface. The City will conduct utility and street re-construction of 2nd Street, 3rd Street, and Jackson Street and excavation of contaminated soil over these areas as needed. The concrete currently serves as a cap over contaminated soil.

2. Is the "Requester" enrolled as a Voluntary Party in the Voluntary Party Liability Exemption (VPLE) program?

No. **Include the fee that is required for your request in Section 3, 4 or 5.**

Yes. **Do not include a separate fee.** This request will be billed separately through the VPLE Program.

**Fill out the information in Section 3, 4 or 5 which corresponds with the type of request:**

**Section 3. Technical Assistance or Post-Closure Modifications;**

**Section 4. Liability Clarification; or Section 5. Specialized Agreement.**

## Section 3. Request for Technical Assistance or Post-Closure Modification

Select the type of technical assistance requested: [Numbers in brackets are for WI DNR Use]

- No Further Action Letter (NFA) (Immediate Actions) - NR 708.09, [183] - **Include a fee of \$350.** Use for a written response to an immediate action after a discharge of a hazardous substance occurs. Generally, these are for a one-time spill event.
- Review of Site Investigation Work Plan - NR 716.09, [135] - **Include a fee of \$700.**
- Review of Site Investigation Report - NR 716.15, [137] - **Include a fee of \$1050.**
- Approval of a Site-Specific Soil Cleanup Standard - NR 720.10 or 12, [67] - **Include a fee of \$1050.**
- Review of a Remedial Action Options Report - NR 722.13, [143] - **Include a fee of \$1050.**
- Review of a Remedial Action Design Report - NR 724.09, [148] - **Include a fee of \$1050.**
- Review of a Remedial Action Documentation Report - NR 724.15, [152] - **Include a fee of \$350**
- Review of a Long-term Monitoring Plan - NR 724.17, [25] - **Include a fee of \$425.**
- Review of an Operation and Maintenance Plan - NR 724.13, [192] - **Include a fee of \$425.**

Other Technical Assistance - s. 292.55, Wis. Stats. [97] (For request to build on an abandoned landfill use Form 4400-226)

- Schedule a Technical Assistance Meeting - **Include a fee of \$700.**
- Hazardous Waste Determination - **Include a fee of \$700.**
- Other Technical Assistance - **Include a fee of \$700.** Explain your request in an attachment.

Post-Closure Modifications - NR 727, [181]

- Post-Closure Modifications: Modification to Property boundaries and/or continuing obligations of a closed site or Property; sites may be on the GIS Registry. This also includes removal of a site or Property from the GIS Registry. **Include a fee of \$1050, and:**
  - Include a fee of \$300 for sites with residual soil contamination; and
  - Include a fee of \$350 for sites with residual groundwater contamination, monitoring wells or for vapor intrusion continuing obligations.

Attach a description of the changes you are proposing, and documentation as to why the changes are needed (if the change to a Property, site or continuing obligation will result in revised maps, maintenance plans or photographs, those documents may be submitted later in the approval process, on a case-by-case basis).

# Technical Assistance, Environmental Liability Clarification or Post-Closure Modification Request

Form 4400-237 (R 12/18)

Page 4 of 7

**Skip Sections 4 and 5 if the technical assistance you are requesting is listed above and complete Sections 6 and 7 of this form.**

## Section 4. Request for Liability Clarification

Select the type of liability clarification requested. Use the available space given or attach information, explanations, or specific questions that you need answered in DNR's reply. Complete Sections 6 and 7 of this form. **[Numbers in brackets are for DNR Use]**

"Lender" liability exemption clarification - s. 292.21, Wis. Stats. [686]

❖ **Include a fee of \$700.**

Provide the following documentation:

- (1) ownership status of the real Property, and/or the personal Property and fixtures;
- (2) an environmental assessment, in accordance with s. 292.21, Wis. Stats.;
- (3) the date the environmental assessment was conducted by the lender;
- (4) the date of the Property acquisition; for foreclosure actions, include a copy of the signed and dated court order confirming the sheriff's sale.
- (5) documentation showing how the Property was acquired and the steps followed under the appropriate state statutes.
- (6) a copy of the Property deed with the correct legal description; and,
- (7) the Lender Liability Exemption Environmental Assessment Tracking Form (Form 4400-196).
- (8) If no sampling was done, please provide reasoning as to why it was **not** conducted. Include this either in the accompanying environmental assessment or as an attachment to this form, and cite language in s. 292.21(1)(c)2., h.-i., Wis. Stats.:
  - h. The collection and analysis of representative samples of soil or other materials in the ground that are suspected of being contaminated based on observations made during a visual inspection of the real Property or based on aerial photographs, or other information available to the lender, including stained or discolored soil or other materials in the ground and including soil or materials in the ground in areas with dead or distressed vegetation. The collection and analysis shall identify contaminants in the soil or other materials in the ground and shall quantify concentrations.
  - i. The collection and analysis of representative samples of unknown wastes or potentially hazardous substances found on the real Property and the determination of concentrations of hazardous waste and hazardous substances found in tanks, drums or other containers or in piles or lagoons on the real Property.

"Representative" liability exemption clarification (e.g. trustees, receivers, etc.) - s. 292.21, Wis. Stats. [686]

❖ **Include a fee of \$700.**

Provide the following documentation:

- (1) ownership status of the Property;
- (2) the date of Property acquisition by the representative;
- (3) the means by which the Property was acquired;
- (4) documentation that the representative has no beneficial interest in any entity that owns, possesses, or controls the Property;
- (5) documentation that the representative has not caused any discharge of a hazardous substance on the Property; and
- (6) a copy of the Property deed with the correct legal description.

Clarification of local governmental unit (LGU) liability exemption at sites with: (select all that apply)

- hazardous substances spills - s. 292.11(9)(e), Wis. Stats. [649];
- Perceived environmental contamination - [649];
- hazardous waste - s. 292.24 (2), Wis. Stats. [649]; and/or
- solid waste - s. 292.23 (2), Wis. Stats. [649].

❖ **Include a fee of \$700, a summary of the environmental liability clarification being requested, and the following:**

- (1) clear supporting documentation showing the acquisition method used, and the steps followed under the appropriate state statute(s).
- (2) current and proposed ownership status of the Property;
- (3) date and means by which the Property was acquired by the LGU, where applicable;
- (4) a map and the ¼, ¼ section location of the Property;
- (5) summary of current uses of the Property;
- (6) intended or potential use(s) of the Property;
- (7) descriptions of other investigations that have taken place on the Property; and
- (8) (for solid waste clarifications) a summary of the license history of the facility.

# Technical Assistance, Environmental Liability Clarification or Post-Closure Modification Request

Form 4400-237 (R 12/18)

Page 5 of 7

## Section 4. Request for Liability Clarification (cont.)

Lease liability clarification - s. 292.55, Wis. Stats. [646]

❖ **Include a fee of \$700 for a single Property, or \$1400 for multiple Properties and the information listed below:**

- (1) a copy of the proposed lease;
- (2) the name of the current owner of the Property and the person who will lease the Property;
- (3) a description of the lease holder's association with any persons who have possession, control, or caused a discharge of a hazardous substance on the Property;
- (4) map(s) showing the Property location and any suspected or known sources of contamination detected on the Property;
- (5) a description of the intended use of the Property by the lease holder, with reference to the maps to indicate which areas will be used. Explain how the use will not interfere with any future investigation or cleanup at the Property; and
- (6) all reports or investigations (e.g. Phase I and Phase II Environmental Assessments and/or Site Investigation Reports conducted under s. NR 716, Wis. Adm. Code) that identify areas of the Property where a discharge has occurred.

General or other environmental liability clarification - s. 292.55, Wis. Stats. [682] - Explain your request below.

❖ **Include a fee of \$700 and an adequate summary of relevant environmental work to date.**

No Action Required (NAR) - NR 716.05, [682]

❖ **Include a fee of \$700.**

Use where an environmental discharge has or has not occurred, and applicant wants a DNR determination that no further assessment or clean-up work is required. Usually this is requested after a Phase I and Phase II environmental assessment has been conducted; the assessment reports should be submitted with this form. This is not a closure letter.

Clarify the liability associated with a "closed" Property - s. 292.55, Wis. Stats. [682]

❖ **Include a fee of \$700.**

- Include a copy of any closure documents if a state agency other than DNR approved the closure.

Use this space or attach additional sheets to provide necessary information, explanations or specific questions to be answered by the DNR. The site was previously investigated and closed on April 7, 2022 with residual soil contamination. The closure also required a cover or barrier over residual contamination. The purpose of this correspondence is to notify WDNR in advance as required in the closure letter that the cap will be removed. Contaminated soil that cannot be managed on the Streets property will be transported to a licensed landfill. The proposed construction is for a development that will include the reconstruction of 2nd Street, 3rd Street and Jackson Street and associated sewer, water and storm water utilities.

REI will work with the City of Wausau to properly manage soil for the street redevelopment. Documentation of street redevelopment will be provided to WDNR and cap maintenance plan for the City Streets.

## Section 5. Request for a Specialized Agreement

Select the type of agreement needed. Include the appropriate draft agreements and supporting materials. Complete Sections 6 and 7 of this form. More information and model draft agreements are available at: [dnr.wi.gov/topic/Brownfields/Igu.html#tabx4](http://dnr.wi.gov/topic/Brownfields/Igu.html#tabx4).

Tax cancellation agreement - s. 75.105(2)(d), Wis. Stats. [654]

❖ **Include a fee of \$700, and the information listed below:**

- (1) Phase I and II Environmental Site Assessment Reports,
- (2) a copy of the Property deed with the correct legal description.

Agreement for assignment of tax foreclosure judgement - s.75.106, Wis. Stats. [666]

❖ **Include a fee of \$700, and the information listed below:**

- (1) Phase I and II Environmental Site Assessment Reports,
- (2) a copy of the Property deed with the correct legal description.

Negotiated agreement - Enforceable contract for non-emergency remediation - s. 292.11(7)(d) and (e), Wis. Stats. [630]

❖ **Include a fee of \$1400, and the information listed below:**

- (1) a draft schedule for remediation; and,
- (2) the name, mailing address, phone and email for each party to the agreement.

Technical Assistance, Environmental Liability  
Clarification or Post-Closure Modification Request

Form 4400-237 (R 12/18)

Page 6 of 7

Section 6. Other Information Submitted

Identify all materials that are included with this request.

Send both a paper copy of the signed form and all reports and supporting materials, and an electronic copy of the form and all reports, including Environmental Site Assessment Reports, and supporting materials on a compact disk.

Include one copy of any document from any state agency files that you want the Department to review as part of this request. The person submitting this request is responsible for contacting other state agencies to obtain appropriate reports or information.

- Phase I Environmental Site Assessment Report - Date: \_\_\_\_\_
- Phase II Environmental Site Assessment Report - Date: \_\_\_\_\_
- Legal Description of Property (required for all liability requests and specialized agreements)
- Map of the Property (required for all liability requests and specialized agreements)

Analytical results of the following sampled media: Select all that apply and include date of collection.

- Groundwater
- Soil
- Sediment
- Other medium - Describe: \_\_\_\_\_

Date of Collection: \_\_\_\_\_

- A copy of the closure letter and submittal materials
- Draft tax cancellation agreement
- Draft agreement for assignment of tax foreclosure judgment
- Other report(s) or information - Describe: \_\_\_\_\_

For Property with newly identified discharges of hazardous substances only: Has a notification of a discharge of a hazardous substance been sent to the DNR as required by s. NR 706.05(1)(b), Wis. Adm. Code?

- Yes - Date (if known): \_\_\_\_\_
- No

Note: The Notification for Hazardous Substance Discharge (non-emergency) form is available at:  
[dnr.wi.gov/files/PDF/forms/4400/4400-225.pdf](http://dnr.wi.gov/files/PDF/forms/4400/4400-225.pdf).

Section 7. Certification by the Person who completed this form

- I am the person submitting this request (requester)
- I prepared this request for: Eric Lindman  
Requester Name

I certify that I am familiar with the information submitted on this request, and that the information on and included with this request is true, accurate and complete to the best of my knowledge. I also certify I have the legal authority and the applicant's permission to make this request.

  
Signature

2/14/2023  
Date Signed

Senior Consultant  
Title

(715) 675-9784  
Telephone Number (include area code)



# Technical Assistance, Environmental Liability Clarification or Post-Closure Modification Request

Form 4400-237 (R 12/18)

Page 7 of 7

## Section 8. DNR Contacts and Addresses for Request Submittals

Send or deliver one paper copy and one electronic copy on a compact disk of the completed request, supporting materials, and fee to the region where the property is located to the address below. Contact a [DNR regional brownfields specialist](#) with any questions about this form or a specific situation involving a contaminated property. For electronic document submittal requirements see: <http://dnr.wi.gov/files/PDF/pubs/rr/RR690.pdf>.

### DNR NORTHERN REGION

Attn: RR Program Assistant  
Department of Natural Resources  
223 E Steinfest Rd Antigo, WI 54409

### DNR NORTHEAST REGION

Attn: RR Program Assistant  
Department of Natural Resources  
2984 Shawano Avenue  
Green Bay WI 54313

### DNR SOUTH CENTRAL REGION

Attn: RR Program Assistant  
Department of Natural Resources  
3911 Fish Hatchery Road  
Fitchburg WI 53711

### DNR SOUTHEAST REGION

Attn: RR Program Assistant  
Department of Natural Resources  
2300 North Martin Luther King Drive  
Milwaukee WI 53212

### DNR WEST CENTRAL REGION

Attn: RR Program Assistant  
Department of Natural Resources  
1300 Clairemont Ave.  
Eau Claire WI 54702

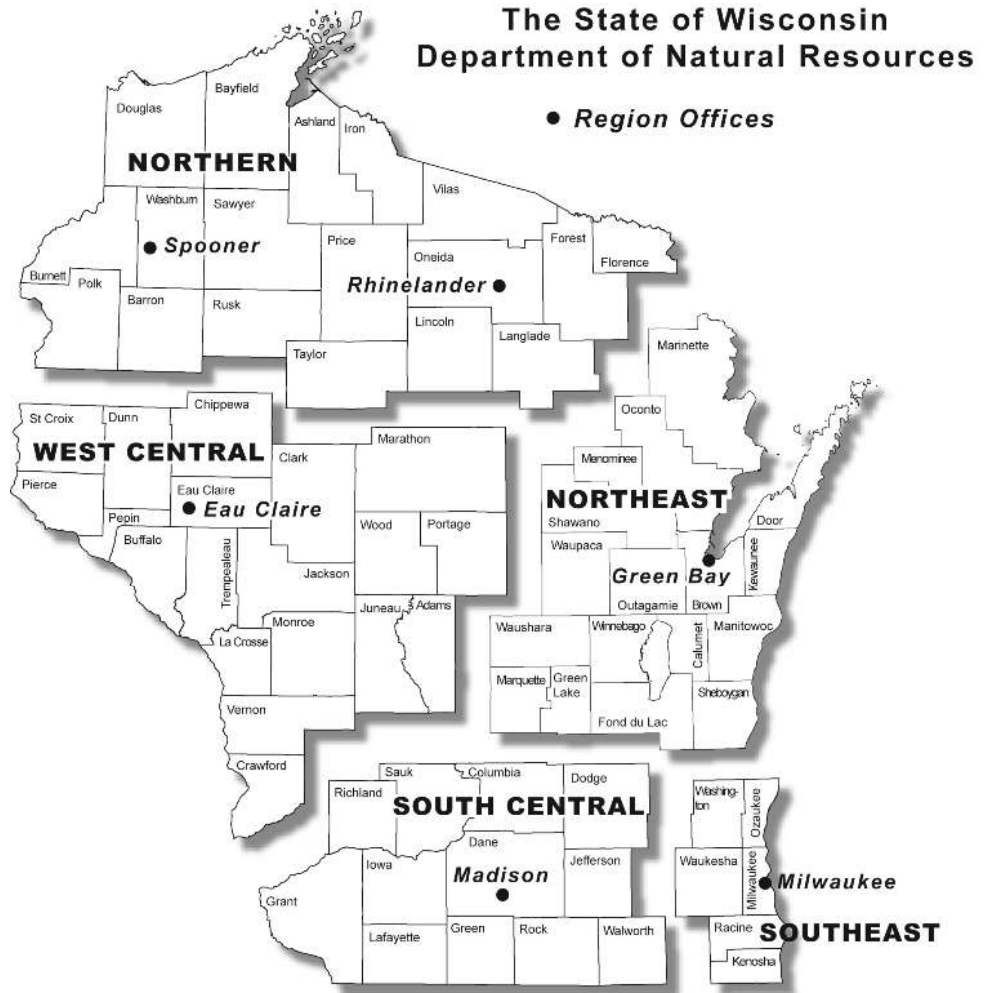

Note: These are the Remediation and Redevelopment Program's designated regions. Other DNR program regional boundaries may be different.

DNR Use Only			
Date Received	Date Assigned	BRRTS Activity Code	BRRTS No. (if used)
DNR Reviewer		Comments	
Fee Enclosed? <input type="radio"/> Yes <input type="radio"/> No	Fee Amount \$	Date Additional Information Requested	Date Requested for DNR Response Letter
Date Approved	Final Determination		

**ATTACHMENT A**

**CASE CLOSURE LETTER – FORMER WAUSAU CENTER MALL**





April 7, 2022

Mr. Eric Lindman  
City of Wausau  
407 Grant Street  
Wausau, WI 54403

**KEEP THIS LEGAL DOCUMENT WITH YOUR PROPERTY RECORDS**

SUBJECT: Case Closure with Continuing Obligations  
Wausau Center Mall (Former), 301 Washington Street, Wausau, WI 54403  
BRRTS #: 02-37-587769

Dear Mr. Lindman:

The Wisconsin Department of Natural Resources (DNR) is pleased to inform you that the Wausau Center Mall (Former) case identified above met the requirements of Wisconsin Administrative (Wis. Admin.) Code chs. NR 700 to 799 for case closure with continuing obligations (COs). COs are legal requirements to address potential exposure to remaining contamination. No further investigation or remediation is required at this time for the reported hazardous substance discharge and/or environmental pollution.

However, you, future property owners and occupants of the property must comply with the COs as explained in this letter, which may include maintaining certain features and notifying the DNR and obtaining approval before taking specific actions. You must provide this letter and all enclosures to anyone who purchases, rents or leases this property from you.

This case closure decision is issued under Wis. Admin. Code chs. NR 700 to 799 and is based on information received by the DNR to date. The DNR reviewed the case closure request for compliance with state laws and standards and determined the case closure request met the notification requirements of Wis. Admin. Code ch. NR 725, the response action goals of Wis. Admin. Code § NR 726.05(4).

The Wausau Center Mall (Former) site was investigated for a discharge of hazardous substances and/or environmental pollution from historic fill located throughout the site. Case closure is granted for the contamination as documented in the case file. The site investigation and/or remedial action addressed soil and groundwater.

The case closure decision and COs required are based on the current use of the source property for commercial purposes. The source property is currently zoned commercial. Based on the land use and zoning, the site, including both the source property and the affected properties, meets the non-industrial land use classification under Wis. Admin. Code § NR 720.05(5) for application of residual contaminant levels in soil.

## SUMMARY OF CONTINUING OBLIGATIONS

COs are applied at the following locations:

ADDRESS (CITY, WI)	COS APPLIED	DATE OF MAINTENANCE PLAN(S)
301 Washington Street (Source Property)	Residual Soil Contamination  Soil Contamination Cap	December 28, 2021

## CLOSURE CONDITIONS

Closure conditions are legally required conditions which include both COs and other requirements for case closure (Wis. Stat. § 292.12(2)). Under Wis. Stat. § 292.12(5), you, any subsequent property owners and occupants of the property must comply with the closure conditions as explained in this letter. The property owner must notify occupants for any condition specified in this letter under Wis. Admin. Code §§ NR 726.15(1)(b) and NR 727.05(2). If an occupant is responsible for maintenance of any closure condition specified in this letter, you and any subsequent property owner must include the condition in the lease agreement under Wis. Admin. Code § NR 727.05(3) and provide the maintenance plan to any occupant that is responsible.

DNR staff may conduct periodic pre-arranged inspections to ensure that the conditions included in this letter and dated December 28, 2021, are met (Wis. Stat. § 292.11(8)). If these requirements are not followed, the DNR may take enforcement action under Wis. Stat. ch. 292 to ensure compliance with the closure conditions.

## SOIL

### *Continuing Obligations to Address Soil Contamination*

Residual Soil Contamination (Wis. Admin. Code chs. NR 718, NR 500 to 599, and § NR 726.15(2)(b) and Wis. Stat. ch. 289)

Soil contamination remains as indicated on the enclosed map (Figure B.2.b., Residual Soil Contamination, 12/01/2021). If soil in the location(s) shown on the map is excavated in the future, the property owner or right of way holder at the time of excavation must sample and analyze the excavated soil. If sampling confirms that contamination is present, the property owner or right of way holder at the time of excavation will need to determine if the material is considered solid waste and ensure that any storage, treatment or disposal complies with applicable standards and rules. Contaminated soil may be managed under Wis. Admin. Code ch. NR 718 with prior DNR approval.

In addition, all current and future property owners, occupants and right of way holders need to be aware that excavation of the contaminated soil may pose an inhalation and direct contact hazard; special precautions may be needed to prevent a threat to human health.

Cover (for soil) (Wis. Stat. § 292.12(2)(a), Wis. Admin. Code §§ NR 724.13(1) and (2), NR 726.15(2)(d) and/or (e), NR 727.07(1))

The impervious barrier as shown on the enclosed map (Figure D.2, Location Map, 12/08/2021) shall be maintained in compliance with the enclosed maintenance plan, dated December 28, 2021. The purpose of the cover is to minimize the infiltration of water through contaminated soil and prevent direct contact with residual soil contamination that might otherwise pose a threat to human health

To modify or replace a cover, the property owner must submit a request to the DNR under Wis. Admin. Code ch. NR 727. The DNR approval must be obtained before implementation. The replacement or modified cover must be a structure of similar permeability or be protective of the revised use of the property until contaminant levels no longer exceed Wis. Admin. Code ch. NR 720 groundwater pathway residual contaminant levels and/or direct contact residual contaminant levels (RCLs).

### **OTHER CLOSURE REQUIREMENTS**

Maintenance Plan and Inspection Log (Wis. Admin. Code §§ NR 726.11(2), NR 726.15(1)(d), NR 727.05(1)(b)3., Wis. Admin. Code § NR 716.14(2) for monitoring wells)

The property owner is required to comply with the enclosed maintenance plan dated December 28, 2021, for the cover to conduct inspections annually, and to use the inspection log (DNR Form 4400-305) to document the required inspections. The maintenance plan and inspection log are to be kept up to date. The property owner shall submit the inspection log to the DNR upon request using the RR Program Submittal Portal. See the DNR Notification and Approval Requirements section below for more information on how to access the Submittal Portal.

The limitations on activities are identified in the enclosed maintenance plan(s). The following activities are prohibited on any portion of this property where the cover is required, without prior DNR approval.

- removal of the existing barrier
- replacement with another barrier
- excavating or grading of the land surface
- filling on capped or paved areas
- plowing for agricultural cultivation
- construction or placement of a building or other structure
- changing the use or occupancy of the property to a residential exposure setting, which may include certain uses, such as single or multiple family residences, a school, day care, senior center, hospital, or similar residential exposure settings.

General Wastewater Permits for Construction-related Dewatering Activities (Wis. Admin. Code ch. NR 200)

The DNR's Water Quality Program regulates point source discharges of contaminated water, including discharges to surface waters, storm sewers, pits, or to the ground surface. This includes discharges from construction-related dewatering activities, including utility work and building construction.

If the property owner or any other person plans to conduct such activities, that person must contact the Water Quality Program and, if necessary, apply for the required discharge permit. If residual soil or groundwater contamination is likely to affect water collected in a pit/trench that requires dewatering, a general permit for discharge of *Contaminated Groundwater from Remedial Action Operations* may be needed. If water collecting in a pit/trench that requires dewatering is expected to be free of pollutants other than suspended solids, oil and grease, a general permit for pit/trench *Dewatering Operations* may be needed. Additional information can be obtained by visiting the DNR website at "dnr.wi.gov," search "wastewater general permits."

### **DNR NOTIFICATION AND APPROVAL REQUIREMENTS**

Certain activities are limited at closed sites to maintain protectiveness to human health and the environment. The property owner is required to notify the DNR at least 45 days before and obtain approval from the DNR prior to taking the following actions (Wis. Admin. Code §§ NR 727.07, NR 726.15 (2), Wis. Stat. § 292.12(6)).

- Before removing a cover or any portion of a cover
- Before changing the use of the property to a non-industrial use, when industrial soil standards were applied for closure

The DNR may require additional investigation and/or cleanup actions, if necessary, to be protective of human health and the environment. The case may be reopened under Wis. Admin. Code § NR 727.13 if additional information indicates that contamination on or from the site poses a threat, or for a lack of compliance with a CO or closure requirement. Compliance with the maintenance plan is considered when evaluating the reopening criteria.

### **SUBMITTALS AND CONTACT INFORMATION**

Site, case-related information and DNR contacts can be found online in the Bureau for Remediation and Redevelopment Tracking System (BRRTS) on the Web (BOTW); go to [dnr.wi.gov](http://dnr.wi.gov) and search “BOTW.” Use the BRRTS ID # found at the top of this letter. The site can also be found on the map view, Remediation and Redevelopment Sites Map (RRSM) by searching “RRSM.”

Send written notifications to the DNR using the RR Program Submittal Portal at [dnr.wi.gov](http://dnr.wi.gov), search “RR submittal portal” (<https://dnr.wi.gov/topic/Brownfields/Submittal.html>). Questions on using this portal can be directed to the Project Manager below or to the environmental program associate (EPA) for the regional DNR office. Visit [dnr.wi.gov](http://dnr.wi.gov), search “RR contacts” and select the EPA tab (<https://dnr.wi.gov/topic/Brownfields/Contact.html>).

### **CLOSING**

The DNR appreciates your efforts to restore the environment at this site. If you have any questions regarding this letter, please contact DNR project manager Matt Thompson at (715) 492-2304 or [matthewa.thompson@wisconsin.gov](mailto:matthewa.thompson@wisconsin.gov).

Sincerely,



Dave Rozeboom  
West Central Region Team Supervisor  
Remediation & Redevelopment Program

Attachments:

Figure B.2.b., Residual Soil Contamination, 12/01/2021

Attachment D, Maintenance Plan, 12/28/2021

Figure D.2, Location Map, 12/08/2021

cc: Ken Lassa, REI Engineering Inc.

DRAWING FILE: P:\194\00-9499\9485E - WAUSAU MALL\DRAWINGS\19485E-Boring Location Map.DWG LAYOUT: B.2.B PLOTTED: Dec 01, 2021 - 3:45PM PLOTTED BY: CHASEK



**LEGEND**

0 100  
SCALE: 1" = 100'

- GEOPROBE SOIL BORING
- MAXIMUM EXTENT SOIL EXCEEDING GROUNDWATER PATHWAY PROTECTION
- MAXIMUM EXTENT SOIL EXCEEDING NON-INDUSTRIAL DIRECT CONTACT RCL
- UNDERGROUND ELECTRIC LINE
- UNDERGROUND FIBER OPTIC LINE
- UNDERGROUND STORM SEWER LINE
- UNDERGROUND SANITARY SEWER LINE
- UNDERGROUND NATURAL GAS LINE
- PROPERTY BOUNDARY

**REI**  
CIVIL & ENVIRONMENTAL  
ENGINEERING, SURVEYING

WAUSAU CENTER MALL (FORMER)  
301 WASHINGTON STREET  
WAUSAU, WI 54403

FIGURE B.2.B RESIDUAL SOIL CONTAMINATION MAP

PROJECT No. 9485E	DRAWN BY: CJK	DATE: 12/01/2021
----------------------	------------------	---------------------

REI Engineering, INC.

**COVER or BARRIER MAINTENANCE PLAN**  
*(to be included in Form 4400-202, as Attachment D)*

December 28, 2021

Property Located at:

301 Washington Street, Wausau, WI 54403

BRRTS #: 02-37-587769

The subject property is comprised of two (2) parcels.

Parcel ID: 291-2907-362-0270

The property is described as: PT OF N/W 1/4 OF SEC 36-29- 07 LOTS 1-8 BLK 24 PT OF VAC WASHINGTON ST PT OF VAC JACKSON ST PT OF VAC N 4TH ST DESD IN CSM VOL 86 PG 23 (17778) DOC #1740752 -- PLAT OF SURVEY 9/26/2016

Parcel ID: 291-2907-362-0260

PT OF ORIG PLAT CITY OF WAUSAU BEING PT OF SEC 36-29-7 COM ON SE COR OF LOT 1 BLK 3 THENCE E 66' S 33' TO PT ON C/L OF WASHINGTON ST THENCE E 281.48' N 0.50' TO POB THENCE E 572' S 21.50' E 29' S 348' W 124' N 28' W 442' S 96' E 71' N 10.5' W 10' N 169' E 19.92' N 42.50' W 19.92' N 176' W 1' N 7' E 67' N 32.50' TO POB 5.292A

The property is in the NW ¼, NW ¼, Section 36, Township 29 North, Range 07 East, City of Wausau, Marathon County, Wisconsin.

Introduction

This document is the Maintenance Plan for a concrete/asphalt cover at the above-referenced property in accordance with the requirements of s. NR 724.13 (2), Wis. Adm. Code. The maintenance activities relate to the existing concrete/asphalt cover which addresses or occupies the area over the contaminated soil.

More site-specific information about this property/site may be found in:

- The case file in the DNR West Central office
- At <http://dnr.wi.gov/topic/Brownfields/wrrd.html>, which includes:
  - BRRTS on the Web (DNR's internet based data base of contaminated sites)for the link to a PDF for site-specific information at the time of closure and on continuing obligations;
  - RR Sites Map for a map view of the site, and
- The DNR project manager for Portage County.

**D.1. Descriptions:**

*(Form 4400-202, Attachment D, Part D1. – brief description of the type, depth and location of residual contamination, description of the system/cover/barrier to be maintained, and its location on the site, maintenance activities, and contact information.)*

Description of Contamination

Laboratory analytical results revealed detections of several compounds in exceedance of NR720 Direct Contact and Groundwater Pathway Protection RCLs. Compounds exceeding Direct Contact standards were primarily



PAHs, with Benzo(a)anthracene, Benzo(a)pyrene, Benzo(b)fluoranthene, Indeno(1,2,3-cd)pyrene commonly detected in the borings. Dibenz(a,h)anthracene exceeded the Direct Contact RCL in two (2) locations, naphthalene exceeded the Direct Contact RCL in one (1) location, and lead exceeded the Direct Contact RCL in one (1) location. Exceedances of the Direct Contact RCL were noted primarily in borings advanced near the center and west side of the property.

Exceedances of NR720 Groundwater Pathway Protection RCLs were also primarily PAHs. Benzo(a)pyrene, Benzo(b)fluoranthene, and Chrysene were detected in exceedance of the Groundwater Pathway Protection RCL in many of the borings, especially those advanced in the center and on the west side of the property. VOCs detected above the Groundwater Pathway Protection RCL included benzene in two (2) locations, naphthalene in three (3) locations, and tetrachloroethene in one (1) location. RCRA metals detected above the Groundwater Pathway Protection RCL included lead in five (5) locations, mercury in two (2) locations, and cadmium in one (1) location. Exceedances of the Groundwater Pathway Protection RCLs were mostly located on the center and west side of the property. Methylene chloride was also detected above the Groundwater Pathway Protection RCLs in many of the samples but is attributable to a laboratory contaminant and is not relevant to this investigation.

Due to observations of subsurface materials, the lack of apparent source, and generally similar contaminant signature noted in samples across the site it is apparent that contamination across the site is resultant from historical fill placed on the site rather than a single point source. Contaminated fill was evidently placed preferentially on the west side of the property as opposed to the east. The extent of soil contamination is depicted on Figure D.2.

#### Description of the [Cover/Barrier] to be Maintained

The concrete/asphalt cover consists several inches of concrete/asphalt remnant from the former Wausau Mall. The entirety of the building had a concrete slab-on-grade foundation which was left in place following demolition of the mall to act as a cover. The concrete slab foundation covers approximately 95% of the property, with the remaining areas consisting of two (2) asphalt parking areas near the northeast portion of the property, and newly added angled asphalt parking located along the northern portion of the property along Washington Street.

#### Cover/Building/Slab/Barrier Purpose

The concrete/asphalt cover over the contaminated soil serves as a barrier to prevent direct human contact with residual soil contamination that might otherwise pose a threat to human health. The cover/barrier also acts as a partial infiltration barrier to minimize future soil-to-groundwater contamination migration that would violate the groundwater standards in ch. NR 140, Wisconsin Administrative Code. Based on the current use of the property as a vacant slab, the barrier should function as intended unless disturbed. Sufficient cover of the property is to be employed during and following redevelopment of the property.

#### Annual Inspection

The concrete/asphalt cover overlying the contaminated soil as depicted in Figure D.2. will be inspected once a year, normally in the spring after all snow and ice is gone, for deterioration, cracks and other potential problems that can cause additional infiltration into or exposure to underlying soils. The inspections will be performed by the property owner or their designated representative. The inspections will be performed to evaluate damage due to settling, exposure to the weather, wear from traffic, increasing age and other factors. Any area where soils have become or are likely to become exposed and where infiltration from the surface will not be effectively minimized will be documented.

A log of the inspections and any repairs will be maintained by the property owner and is included as D.4, Form

4400-305, Continuing Obligations Inspection and Maintenance Log. The log will include recommendations for necessary repair of any areas where underlying soils are exposed and where infiltration from the surface will not be effectively minimized. Once repairs are completed, they will be documented in the inspection log. A copy of the maintenance plan and inspection log will be kept at the site; or, if there is no acceptable place (for example, no building is present) to keep it at the site, at the address of the property owner and available for submittal or inspection by Wisconsin Department of Natural Resources (DNR) representatives upon their request.

#### Maintenance Activities

*(Form 4400-202, Attachment D, Part D1. – Description of Maintenance Actions required for maximizing effectiveness of the cover/barrier/engineered control, feature or other action for which maintenance is required.)*

If problems are noted during the annual inspections or at any other time during the year, repairs will be scheduled as soon as practical. Repairs can include patching and filling or larger resurfacing or construction operations. In the event that necessary maintenance activities expose the underlying soil, the owner must inform maintenance workers of the direct contact exposure hazard and provide them with appropriate personal protection equipment (PPE). The owner must also sample any soil that is excavated from the site prior to disposal to ascertain if contamination remains. The soil must be treated, stored and disposed of by the owner in accordance with applicable local, state and federal law.

In the event the concrete/asphalt cover overlying the contaminated groundwater plume and soil are removed or replaced, the replacement barrier must be equally impervious. Any replacement barrier will be subject to the same maintenance and inspection guidelines as outlined in this Maintenance Plan unless indicated otherwise by the DNR or its successor.

The property owner, in order to maintain the integrity of the concrete/asphalt cover, will maintain a copy of this Maintenance Plan at the site; or, if there is no acceptable place to keep it at the site (for example, no building is present), at the address of the property owner and make it available to all interested parties (i.e. on-site employees, contractors, future property owners, etc.) for viewing.

#### Prohibition of Activities and Notification of DNR Prior to Actions Affecting a Cover/Barrier

The following activities are prohibited on any portion of the property where pavement/concrete is required as shown on the attached map, unless prior written approval has been obtained from the Wisconsin Department of Natural Resources: 1) removal of the existing barrier; 2) replacement with another barrier; 3) excavating or grading of the land surface; 4) filling on capped or paved areas; 5) plowing for agricultural cultivation; 6) construction or placement of a building or other structure; 7) changing the use or occupancy of the property to a residential exposure setting, which may include certain uses, such as single or multiple family residences, a school, day care, senior center, hospital, or similar residential exposure settings.

If removal, replacement or other changes to a cover, or a building which is acting as a cover, are considered, the property owner will contact DNR at least 45 days before taking such an action, to determine whether further action may be necessary to protect human health, safety, or welfare or the environment, in accordance with s. NR 727.07, Wis. Adm. Code.

#### Amendment or Withdrawal of Maintenance Plan

This Maintenance Plan can be amended or withdrawn by the property owner and its successors with the written approval of DNR.

Contact Information

(Form 4400-202, Attachment D, Part 1.) Contact Information, including the name, address and phone number of the individual or facility who will be conducting the maintenance.)

Site Owner and Operator:      Wausau Opportunity Zone, Inc.  
500 N First Street, Suite 8000, Wausau, WI 54403  
(715) 845-6231

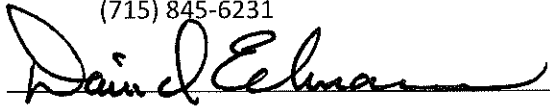
Signature:       \_\_\_\_\_

(DNR may request signature of affected property owners, on a case-by-case basis)

Property Owner:                Wausau Opportunity Zone, Inc.  
500 N First Street, Suite 8000, Wausau, WI 54403  
(715) 845-6231

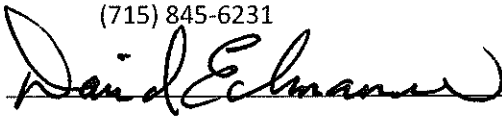
Signature:       \_\_\_\_\_

Consultant:                      REI Engineering, Inc  
4080 N 20<sup>th</sup> Avenue, Wausau, WI 54401  
(715) 675-9784

DNR:                                Matt Thompson  
1300 W. Clairemont Avenue, Eau Claire, WI 54701  
(715) 492-2304

DRAWING FILE: P:\194,00-9499\19485E - WAUSAU MALL\Drawings\19485E-Boring Location Map.dwg LAYOUT: D.2 PLOTTED: DEC 08, 2021 - 11:34AM PLOTTED BY: CHASEK



**LEGEND**

0 100  
SCALE: 1" = 100'

- EXTENT OF CONCRETE AND ASPHALT COVER THAT REQUIRE MAINTENANCE (ENTIRE PROPERTY)
- MONITORING WELL
- MAXIMUM EXTENT GROUNDWATER EXCEEDING PREVENTATIVE ACTION LIMIT (BARIUM)
- GEOPROBE SOIL BORING
- MAXIMUM EXTENT SOIL EXCEEDING GROUNDWATER PATHWAY PROTECTION
- MAXIMUM EXTENT SOIL EXCEEDING NON-INDUSTRIAL DIRECT CONTACT RCL
- UNDERGROUND ELECTRIC LINE
- UNDERGROUND FIBER OPTIC LINE
- UNDERGROUND STORM SEWER LINE
- UNDERGROUND SANITARY SEWER LINE
- UNDERGROUND NATURAL GAS LINE
- PROPERTY BOUNDARY



WAUSAU CENTER MALL (FORMER)  
301 WASHINGTON STREET  
WAUSAU, WI 54403

FIGURE D:2 LOCATION MAP

PROJECT No. 9485E	DRAWN BY: CJK	DATE: 12/08/2021
----------------------	------------------	---------------------

REI Engineering, INC.

**ATTACHMENT B**

**ALEXANDER DAVIS PLAT OF FORMER WAUSAU CENTER MALL  
PROPERTY**



# MUNICIPAL PLAT OF ALEXANDER DAVIS PLAT

ALL OF LOT 1 OF CERTIFIED SURVEY MAP NUMBER 17778, RECORDED IN VOLUME 86, ON PAGE 23, AS DOCUMENT NUMBER 1740752 AND PART OF CERTIFIED SURVEY MAP NUMBER 2264, RECORDED IN VOLUME 9, ON PAGE 48, AS DOCUMENT NUMBER 756295, BOTH FILED IN THE MARATHON COUNTY REGISTER OF DEEDS OFFICE; ALSO KNOWN AS BLOCKS 9, 10, 11, 12, 19, 20, 23, AND 24 OF THE ORIGINAL PLAT OF THE CITY OF WAUSAU, VACATED JACKSON STREET, VACATED WASHINGTON STREET, VACATED SECOND STREET, VACATED THIRD STREET, AND VACATED FOURTH STREET; ALL LOCATED IN GOVERNMENT LOT 5 OF SECTION 36, TOWNSHIP 29 NORTH, RANGE 7 EAST, CITY OF WAUSAU, MARATHON COUNTY, WISCONSIN.

### GENERAL NOTES:

- BEARINGS ARE BASED ON THE MARATHON COUNTY COORDINATE SYSTEM, NAD83 (2011) DATUM, AND ARE REFERENCED TO THE WEST LINE OF THE NORTHWEST 1/4 SECTION 36, TOWNSHIP 29 NORTH, RANGE 7 EAST, MEASURED TO BEAR SOUTH 02°11'33" EAST.
- SUBJECT PROPERTY IS LOCATED IN THE PUD (PUBLIC UNIT DEVELOPMENT) ZONING WHICH THERE ARE NO SETBACKS.
- FIELDWORK WAS COMPLETED ON 06/20/2022.
- LANDS LOCATED WEST OF NORTH 2ND STREET WILL BE SUBJECT TO THE WAUSAU OPPORTUNITY ZONE CONDOMINIUM PENDING APPROVAL.
- OUTLOT 5, 7, & 8 ARE DEDICATED TO THE PUBLIC WITH THE RECORDING OF THE SUBJECT PLAT.

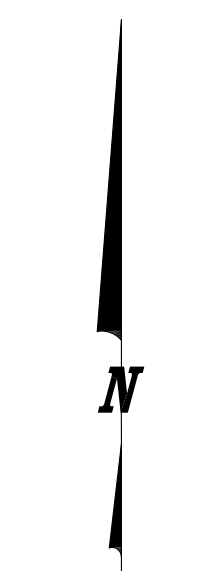

1" = 60'  
0 60

LEGEND	
	PK NAIL FOUND
	DRILL HOLE FOUND
	CHISELED "X" FOUND
	1-1/4 IN. O.D. IRON PIPE FOUND
	SET DRILL HOLE
	RECORDED BEARING/LENGTH
	MEASURED BEARING/LENGTH
	EXISTING BUILDING LINE

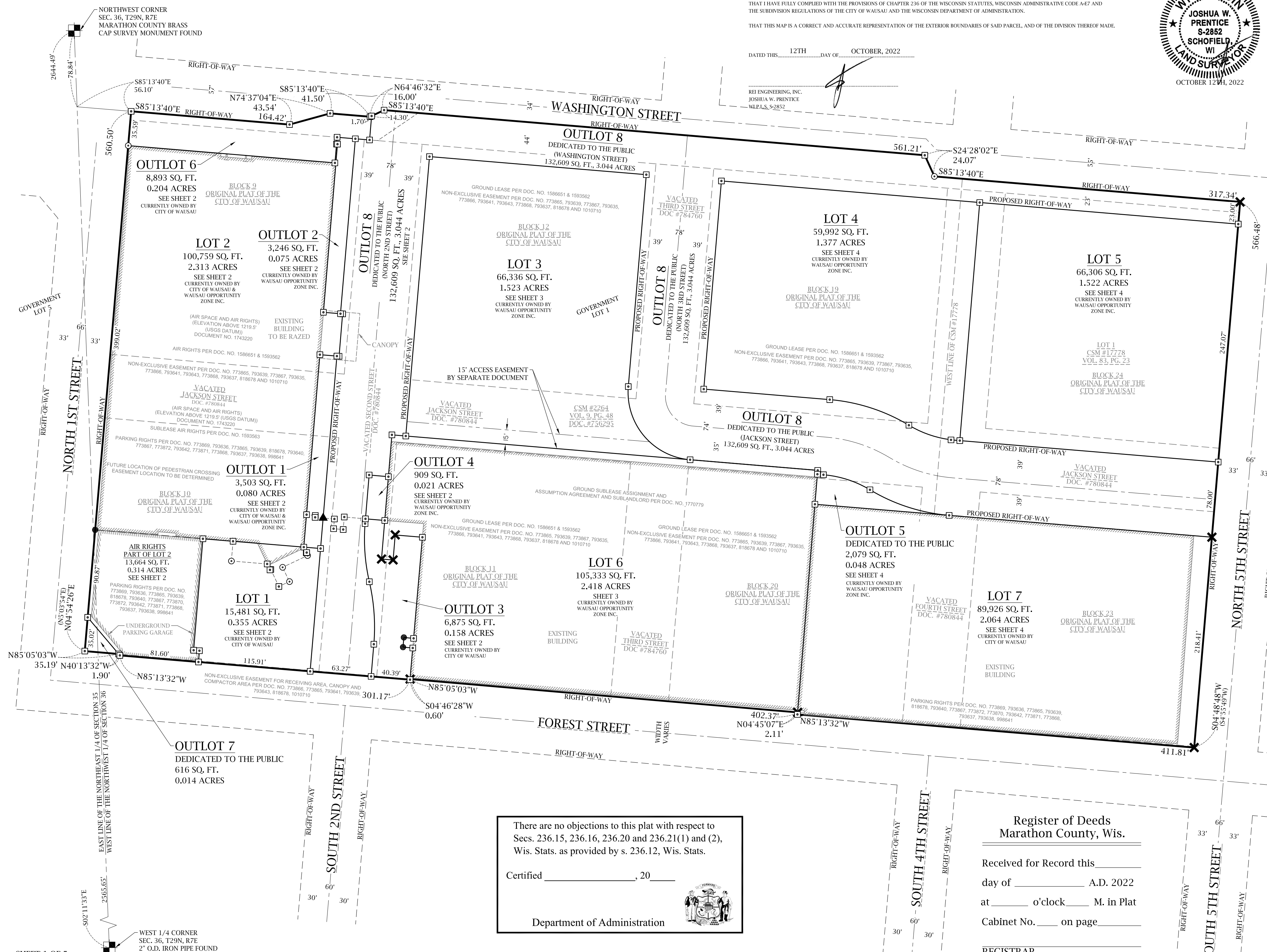
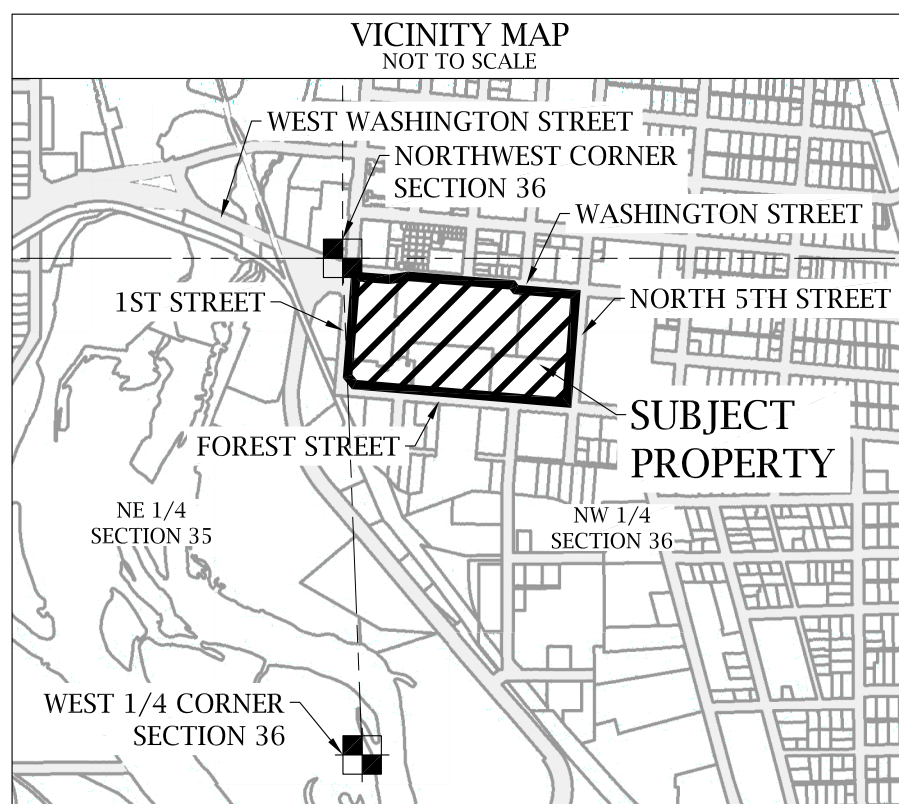

### SURVEYOR'S CERTIFICATE

I, JOSHUA W. PRENTICE, WISCONSIN PROFESSIONAL LAND SURVEYOR S-2852, DO HEREBY CERTIFY TO THE BEST OF MY KNOWLEDGE AND BELIEF THAT I HAVE SURVEYED, MAPPED AND DIVIDED A PARCEL OF LAND BEING PART OF CERTIFIED SURVEY MAP NUMBER 2264, RECORDED IN VOLUME 9, ON PAGE 48, AS DOCUMENT NUMBER 756295 AND BEING ALL OF LOT 1 OF CERTIFIED SURVEY MAP NUMBER 17778, RECORDED IN VOLUME 86, ON PAGE 23, AS DOCUMENT NUMBER 1740752 AND PART OF CERTIFIED SURVEY MAP NUMBER 2264, RECORDED IN VOLUME 9, ON PAGE 48, AS DOCUMENT NUMBER 756295, BOTH FILED IN THE MARATHON COUNTY REGISTER OF DEEDS OFFICE; ALSO KNOWN AS BLOCKS 9, 10, 11, 12, 19, 20, 23, AND 24 OF THE ORIGINAL PLAT OF THE CITY OF WAUSAU, VACATED JACKSON STREET, VACATED WASHINGTON STREET, VACATED SECOND STREET, VACATED THIRD STREET, AND VACATED FOURTH STREET; ALL LOCATED IN GOVERNMENT LOT 5 OF SECTION 36, TOWNSHIP 29 NORTH, RANGE 7 EAST, CITY OF WAUSAU, MARATHON COUNTY, WISCONSIN, MORE PARTICULARLY DESCRIBED AS FOLLOWS:

COMMENCING AT THE NORTHWEST CORNER OF SAID SECTION 36; THENCE SOUTH 02°11'33" EAST, COINCIDENT WITH THE WEST LINE OF THE NORTHWEST 1/4 OF SAID SECTION 36, 78.84 FEET TO A POINT BEING THE WESTERLY EXTENSION OF THE SOUTH RIGHT-OF-WAY LINE OF WASHINGTON STREET; THENCE SOUTH 85°13'40" EAST, COINCIDENT WITH SAID WESTERLY EXTENSION OF THE SOUTH RIGHT-OF-WAY LINE OF WASHINGTON STREET, 56.10 FEET TO THE INTERSECTION OF SAID SOUTH RIGHT-OF-WAY LINE OF WASHINGTON STREET WITH THE EAST RIGHT-OF-WAY LINE OF NORTH 1ST STREET; THENCE CONTINUING SOUTH 85°13'40" EAST, COINCIDENT WITH SAID SOUTH RIGHT-OF-WAY LINE, 164.42 FEET; THENCE NORTH 74°27'04" EAST, COINCIDENT WITH SAID SOUTH RIGHT-OF-WAY LINE, 43.54 FEET; THENCE SOUTH 85°13'40" EAST, COINCIDENT WITH SAID SOUTH RIGHT-OF-WAY LINE, 16.00 FEET; THENCE NORTH 64°46'32" EAST, COINCIDENT WITH SAID SOUTH RIGHT-OF-WAY LINE, 16.00 FEET; THENCE SOUTH 85°13'40" EAST, COINCIDENT WITH SAID SOUTH RIGHT-OF-WAY LINE, 56.21 FEET; THENCE SOUTH 24°29'02" EAST, COINCIDENT WITH SAID SOUTH RIGHT-OF-WAY LINE, 24.07 FEET; THENCE SOUTH 85°13'40" EAST, COINCIDENT WITH SAID SOUTH RIGHT-OF-WAY LINE, 317.34 FEET TO THE INTERSECTION OF SAID SOUTH RIGHT-OF-WAY LINE OF WASHINGTON STREET WITH THE WEST RIGHT-OF-WAY LINE OF NORTH 1ST STREET; THENCE SOUTH 85°13'40" WEST, COINCIDENT WITH SAID SOUTH RIGHT-OF-WAY LINE, 566.48 FEET TO THE INTERSECTION OF SAID WEST RIGHT-OF-WAY LINE OF NORTH 1ST STREET WITH THE NORTH RIGHT-OF-WAY LINE OF FOREST STREET; THENCE NORTH 85°13'32" WEST, COINCIDENT WITH SAID NORTH RIGHT-OF-WAY LINE, 411.81 FEET; THENCE NORTH 04°43'07" EAST, COINCIDENT WITH SAID NORTH RIGHT-OF-WAY LINE, 2.11 FEET; THENCE NORTH 85°05'03" WEST, COINCIDENT WITH SAID NORTH RIGHT-OF-WAY LINE, 402.37 FEET; THENCE SOUTH 04°46'28" WEST, COINCIDENT WITH SAID NORTH RIGHT-OF-WAY LINE, 0.60 FEET; THENCE NORTH 85°13'32" WEST, COINCIDENT WITH SAID NORTH RIGHT-OF-WAY LINE, 35.19 FEET TO THE INTERSECTION OF SAID NORTH RIGHT-OF-WAY LINE OF FOREST STREET AND SAID EAST RIGHT-OF-WAY LINE OF NORTH 1ST STREET; THENCE NORTH 04°54'20" EAST, COINCIDENT WITH SAID EAST RIGHT-OF-WAY LINE, 560.50 FEET TO SAID INTERSECTION OF THE SOUTH RIGHT-OF-WAY LINE OF WASHINGTON STREET WITH THE EAST RIGHT-OF-WAY LINE OF NORTH 1ST STREET, AND BEING THE POINT OF BEGINNING.

THAT THE ABOVE DESCRIBED PARCEL OF LAND CONTAINS 662,863 SQUARE FEET, 15.247 ACRES, MORE OR LESS.

THAT I HAVE MADE THIS SURVEY, DIVISION AND MAP THEREOF AT THE DIRECTION OF THE WAUSAU OPPORTUNITY ZONE INC., AGENT OF SAID PARCEL.

THAT SAID PARCEL IS SUBJECT TO EASEMENTS, RESTRICTIONS, AND RIGHT-OF-WAYS OF RECORD.

THAT I HAVE FULLY COMPLIED WITH THE PROVISIONS OF CHAPTER 236 OF THE WISCONSIN STATUTES, WISCONSIN ADMINISTRATIVE CODE A-47 AND THE SUBDIVISION REGULATIONS OF THE CITY OF WAUSAU AND THE WISCONSIN DEPARTMENT OF ADMINISTRATION.

THAT THIS MAP IS A CORRECT AND ACCURATE REPRESENTATION OF THE EXTERIOR BOUNDARIES OF SAID PARCEL, AND OF THE DIVISION THEREOF MADE.

DATED THIS 12TH DAY OF OCTOBER, 2022

REI ENGINEERING, INC.  
JOSHUA W. PRENTICE  
W.L.S. S-2852

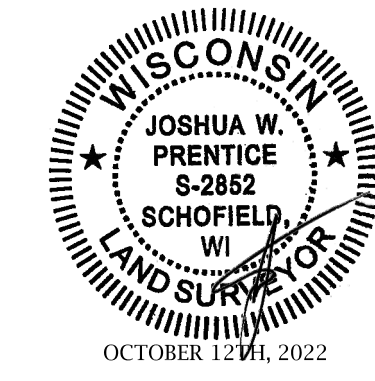

There are no objections to this plat with respect to Secs. 236.15, 236.16, 236.20 and 236.21(1) and (2), Wis. Stats. as provided by s. 236.12, Wis. Stats.

Certified \_\_\_\_\_, 20\_\_\_\_

Department of Administration

Register of Deeds  
Marathon County, Wis.

Received for Record this \_\_\_\_\_ day of \_\_\_\_\_ A.D. 2022 at \_\_\_\_\_ o'clock \_\_\_\_\_ M. in Plat Cabinet No. \_\_\_\_\_ on page \_\_\_\_\_

REGISTRAR

DATE	REVISION	BY	CHK'D
10/12/2022	REVISED PER COMMENTS	JLR	JWP

REI Engineering, Inc.  
1401 N. 20TH AVENUE  
WAUSAU, WISCONSIN 54980  
PHONE: 715.875.0750 FAX: 715.875.0200  
EMAIL: MAIL@REIENGINEERING.COM

**REI** CIVIL & ENVIRONMENTAL ENGINEERING, SURVEYING

SHEET 1 OF 5  
REI PROJECT #9485

MUNICIPAL PLAT OF  
**ALEXANDER DAVIS PLAT**

ALL OF LOT 1 OF CERTIFIED SURVEY MAP NUMBER 17778, RECORDED IN VOLUME 86, ON PAGE 23, AS DOCUMENT NUMBER 1740752 AND PART OF CERTIFIED SURVEY MAP NUMBER 2264, RECORDED IN VOLUME 9, ON PAGE 48, AS DOCUMENT NUMBER 756295, BOTH FILED IN THE MARATHON COUNTY REGISTER OF DEEDS OFFICE; ALSO KNOWN AS BLOCKS 9, 10, 11, 12, 19, 20, 23, AND 24 OF THE ORIGINAL PLAT OF THE CITY OF WAUSAU, VACATED JACKSON STREET, VACATED WASHINGTON STREET, VACATED SECOND STREET, VACATED THIRD STREET, AND VACATED FOURTH STREET; ALL LOCATED IN GOVERNMENT LOT 5 OF SECTION 35 AND GOVERNMENT LOT 1 OF SECTION 36, TOWNSHIP 29 NORTH, RANGE 7 EAST, CITY OF WAUSAU, MARATHON COUNTY, WISCONSIN.

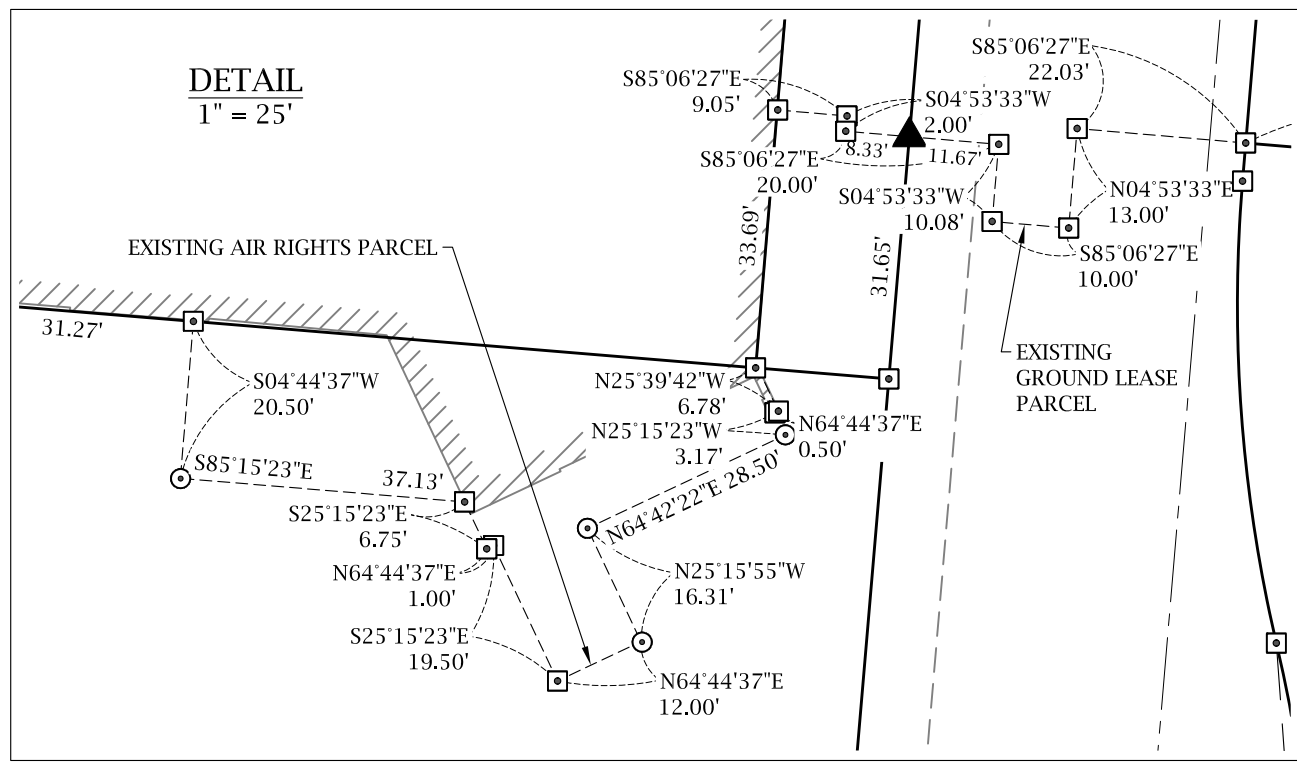
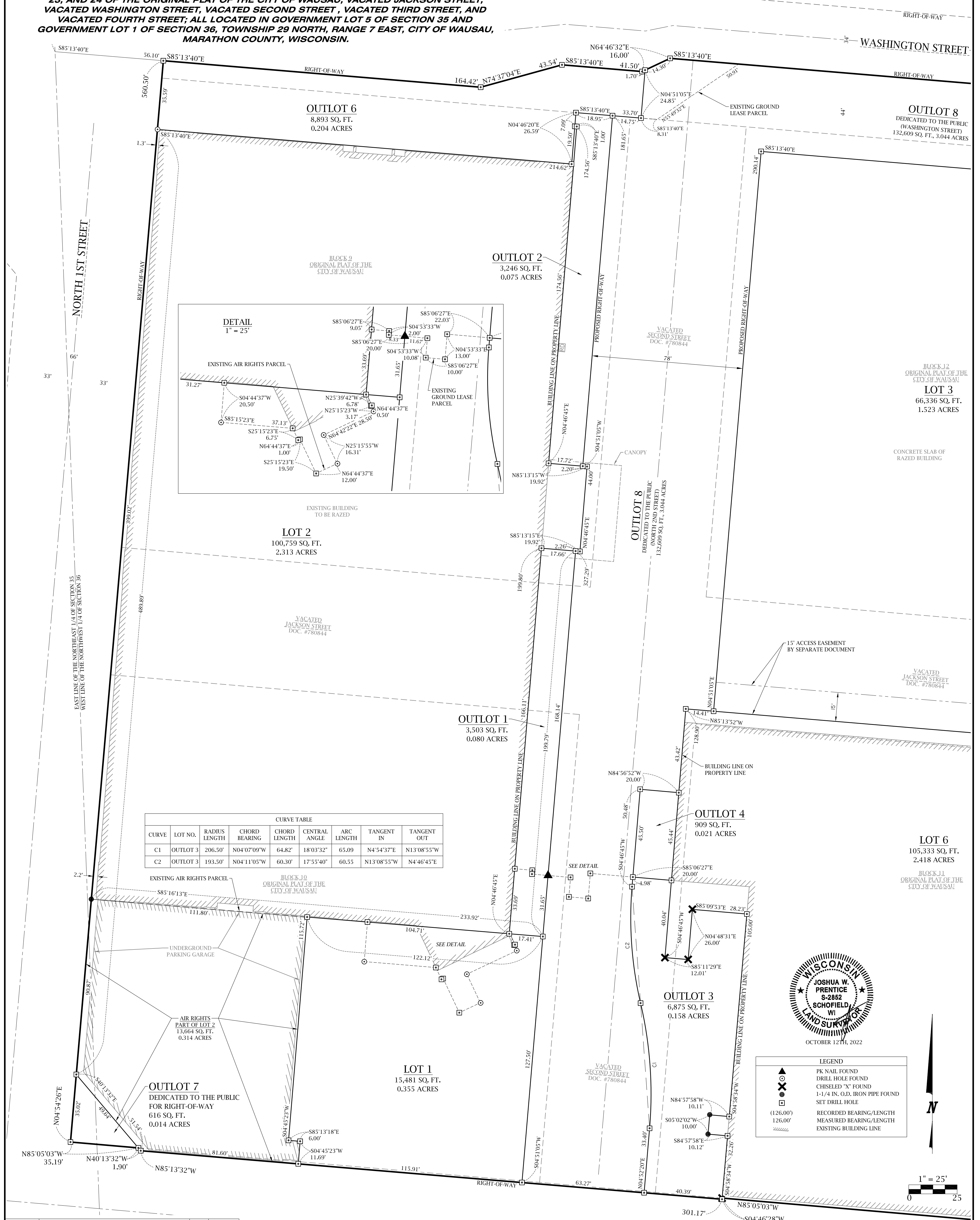

CURVE TABLE								
CURVE	LOT NO.	RADIUS LENGTH	CHORD BEARING	CHORD LENGTH	CENTRAL ANGLE	ARC LENGTH	TANGENT IN	TANGENT OUT
C1	OUTLOT 3	206.50'	N04°07'09\"W	64.82'	18°03'32\"	65.09'	N4°54'37\"E	N13°08'55\"W
C2	OUTLOT 3	193.50'	N04°11'05\"W	60.30'	17°55'40\"	60.55'	N13°08'55\"W	N4°46'45\"E



LEGEND	
	PK NAIL FOUND
	DRILL HOLE FOUND
	CHISELED "X" FOUND
	1-1/4 IN. O.D. IRON PIPE FOUND
	SET DRILL HOLE
	RECORDED BEARING/LENGTH
	MEASURED BEARING/LENGTH
	EXISTING BUILDING LINE

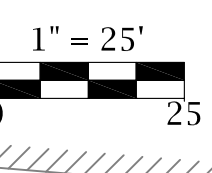

# MUNICIPAL PLAT OF ALEXANDER DAVIS PLAT

ALL OF LOT 1 OF CERTIFIED SURVEY MAP NUMBER 17778, RECORDED IN VOLUME 86, ON PAGE 23, AS DOCUMENT NUMBER 1740752 AND PART OF CERTIFIED SURVEY MAP NUMBER 2264, RECORDED IN VOLUME 9, ON PAGE 48, AS DOCUMENT NUMBER 756295, BOTH FILED IN THE MARATHON COUNTY REGISTER OF DEEDS OFFICE; ALSO KNOWN AS BLOCKS 9, 10, 11, 12, 19, 20, 23, AND 24 OF THE ORIGINAL PLAT OF THE CITY OF WAUSAU, VACATED JACKSON STREET, VACATED SECOND STREET, VACATED THIRD STREET, AND VACATED FOURTH STREET; ALL LOCATED IN GOVERNMENT LOT 5 OF SECTION 35 AND GOVERNMENT LOT 1 OF SECTION 36, TOWNSHIP 29 NORTH, RANGE 7 EAST, CITY OF WAUSAU, MARATHON COUNTY, WISCONSIN.

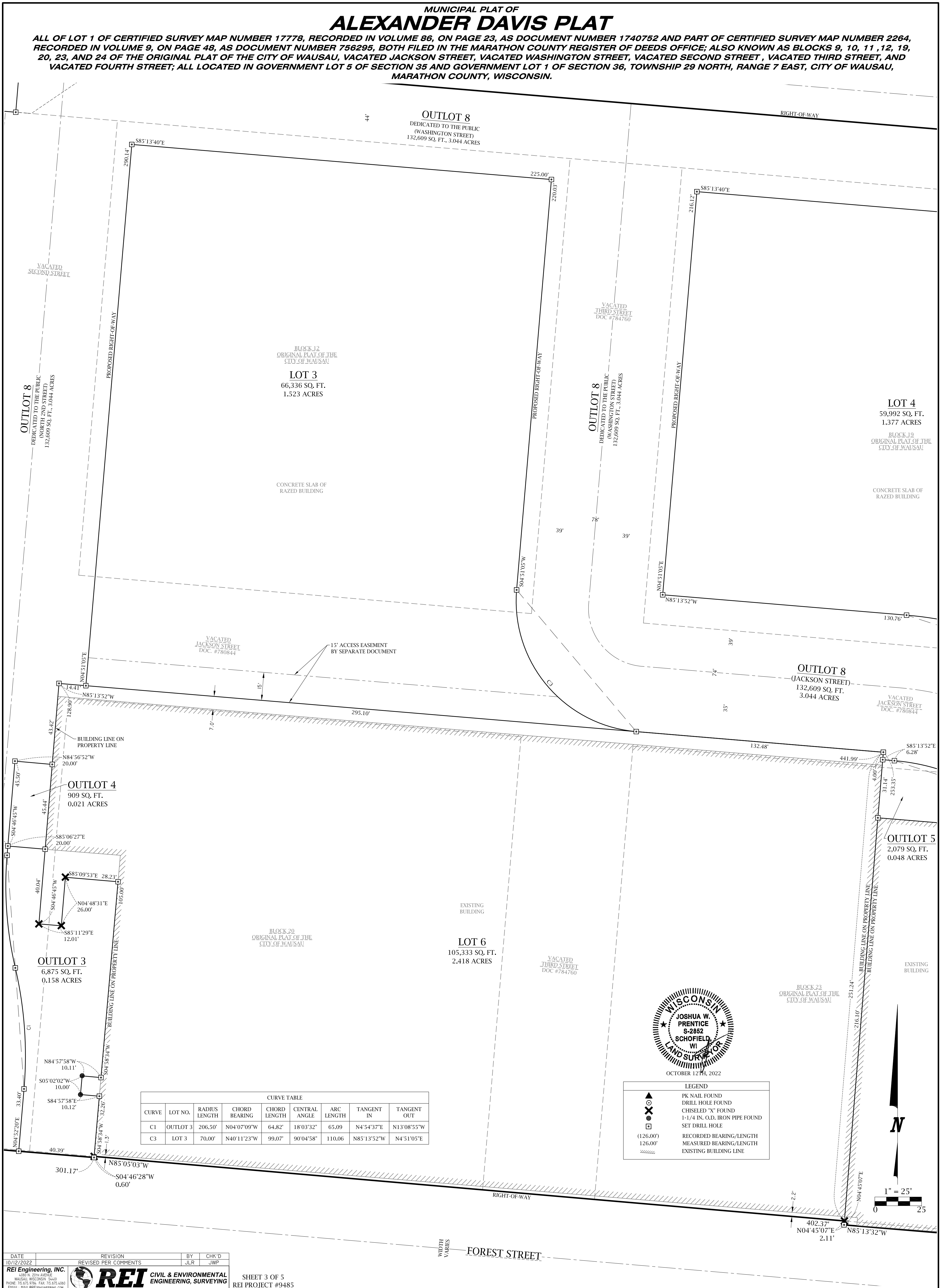

BLOCK 12  
ORIGINAL PLAT OF THE  
CITY OF WAUSAU  
**LOT 3**  
66,336 SQ. FT.  
1.523 ACRES

**OUTLOT 8**  
DEDICATED TO THE PUBLIC  
(WASHINGTON STREET)  
132,609 SQ. FT., 3.044 ACRES

**OUTLOT 8**  
DEDICATED TO THE PUBLIC  
(WASHINGTON STREET)  
132,609 SQ. FT., 3.044 ACRES

**LOT 4**  
59,992 SQ. FT.  
1.377 ACRES  
BLOCK 19  
ORIGINAL PLAT OF THE  
CITY OF WAUSAU

CONCRETE SLAB OF  
RAZED BUILDING

VACATED  
JACKSON STREET  
DOC. #780844

15' ACCESS EASEMENT  
BY SEPARATE DOCUMENT

**OUTLOT 8**  
(JACKSON STREET)  
132,609 SQ. FT.  
3.044 ACRES

VACATED  
JACKSON STREET  
DOC. #780844

**OUTLOT 4**  
909 SQ. FT.  
0.021 ACRES

**OUTLOT 3**  
6,875 SQ. FT.  
0.158 ACRES

EXISTING  
BUILDING  
**LOT 6**  
105,333 SQ. FT.  
2.418 ACRES

**OUTLOT 5**  
2,079 SQ. FT.  
0.048 ACRES

BLOCK 20  
ORIGINAL PLAT OF THE  
CITY OF WAUSAU

VACATED  
THIRD STREET  
DOC #784760

BLOCK 23  
ORIGINAL PLAT OF THE  
CITY OF WAUSAU



LEGEND

	PK NAIL FOUND
	DRILL HOLE FOUND
	CHISELED "X" FOUND
	1-1/4 IN. O.D. IRON PIPE FOUND
	SET DRILL HOLE
	RECORDED BEARING/LENGTH
	MEASURED BEARING/LENGTH
	EXISTING BUILDING LINE

CURVE TABLE

CURVE	LOT NO.	RADIUS LENGTH	CHORD BEARING	CHORD LENGTH	CENTRAL ANGLE	ARC LENGTH	TANGENT IN	TANGENT OUT
C1	OUTLOT 3	206.50'	N04°07'09"W	64.82'	18°03'32"	65.09	N4°54'37"E	N13°08'55"W
C3	LOT 3	70.00'	N40°11'23"W	99.07'	90°04'58"	110.06	N85°13'52"W	N4°51'05"E

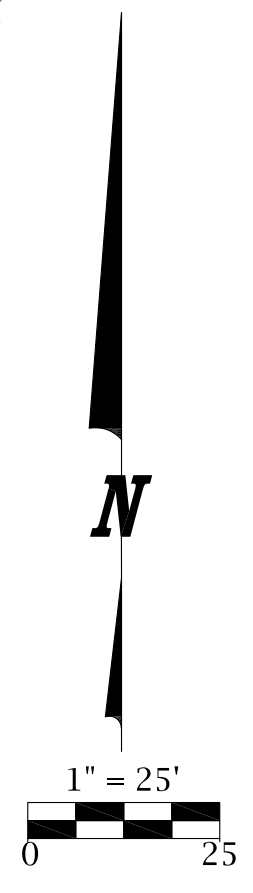



MUNICIPAL PLAT OF  
**ALEXANDER DAVIS PLAT**

ALL OF LOT 1 OF CERTIFIED SURVEY MAP NUMBER 17778, RECORDED IN VOLUME 86, ON PAGE 23, AS DOCUMENT NUMBER 1740752 AND PART OF CERTIFIED SURVEY MAP NUMBER 2264, RECORDED IN VOLUME 9, ON PAGE 48, AS DOCUMENT NUMBER 756295, BOTH FILED IN THE MARATHON COUNTY REGISTER OF DEEDS OFFICE; ALSO KNOWN AS BLOCKS 9, 10, 11, 12, 19, 20, 23, AND 24 OF THE ORIGINAL PLAT OF THE CITY OF WAUSAU, VACATED JACKSON STREET, VACATED WASHINGTON STREET, VACATED SECOND STREET, VACATED THIRD STREET, AND VACATED FOURTH STREET; ALL LOCATED IN GOVERNMENT LOT 5 OF SECTION 35 AND GOVERNMENT LOT 1 OF SECTION 36, TOWNSHIP 29 NORTH, RANGE 7 EAST, CITY OF WAUSAU, MARATHON COUNTY, WISCONSIN.

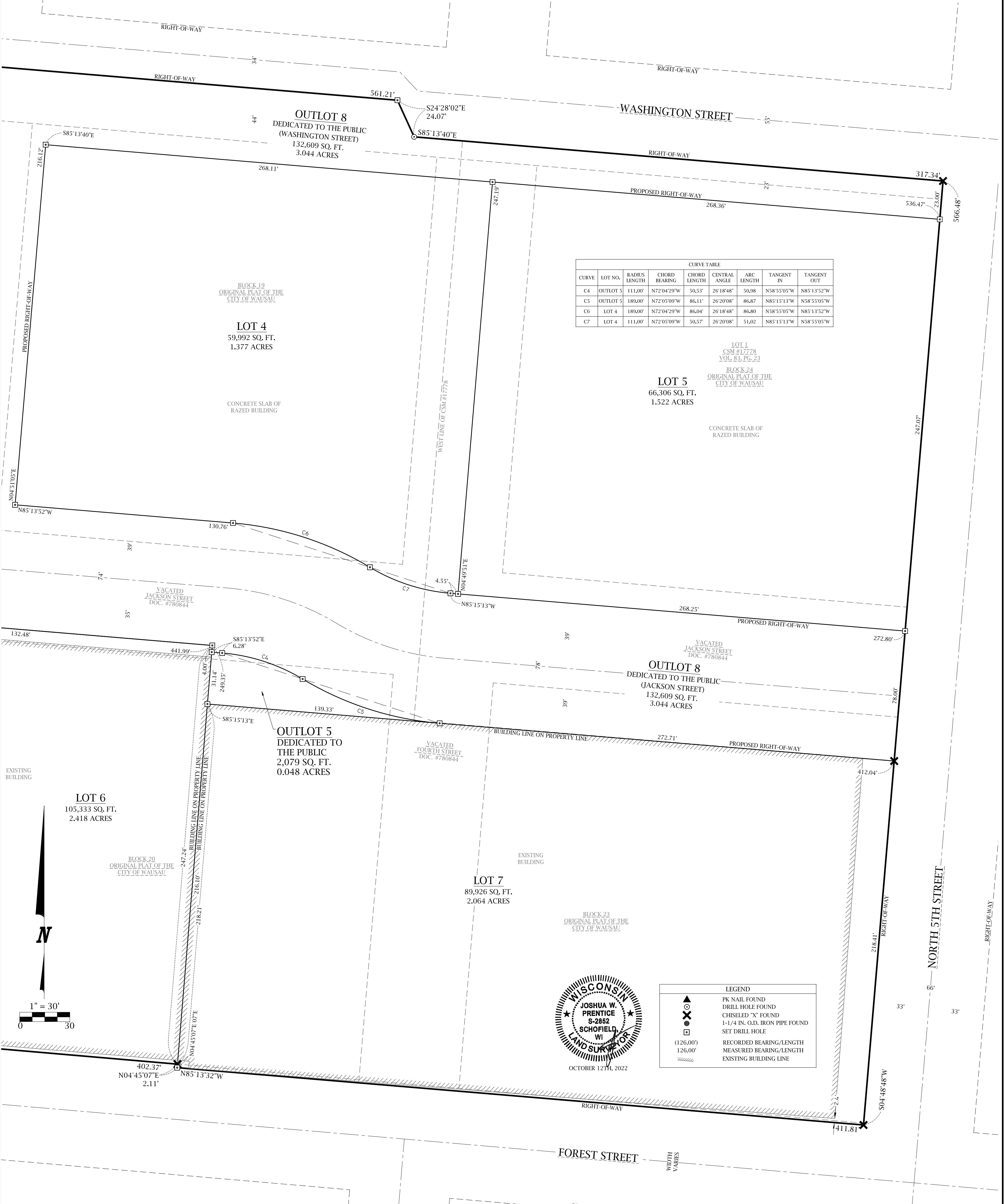

CURVE TABLE							
CURVE	LOT NO.	RADIUS LENGTH	CHORD BEARING	CHORD LENGTH	CENTRAL ANGLE	ARC LENGTH	TANGENT IN / TANGENT OUT
C4	OUTLOT 5	111.00'	N72°04'29"W	50.53'	26°18'48"	50.98'	N58°55'05"W N85°13'52"W
C5	OUTLOT 5	189.00'	N72°05'09"W	86.11'	26°20'08"	86.87'	N85°15'13"W N58°55'05"W
C6	LOT 4	189.00'	N72°04'29"W	86.04'	26°18'48"	86.80'	N58°55'05"W N85°13'52"W
C7	LOT 4	111.00'	N72°05'09"W	50.57'	26°20'08"	51.02'	N85°15'13"W N58°55'05"W

LOT 1  
CSM #17778  
VOL. 86, PG. 23

BLOCK 24  
ORIGINAL PLAT OF THE  
CITY OF WAUSAU

LOT 5  
66,306 SQ. FT.  
1.522 ACRES

CONCRETE SLAB OF  
RAZED BUILDING

BLOCK 19  
ORIGINAL PLAT OF THE  
CITY OF WAUSAU

LOT 4  
59,992 SQ. FT.  
1.377 ACRES

CONCRETE SLAB OF  
RAZED BUILDING

OUTLOT 5  
DEDICATED TO  
THE PUBLIC  
2,079 SQ. FT.  
0.048 ACRES

OUTLOT 8  
DEDICATED TO THE PUBLIC  
(JACKSON STREET)  
132,609 SQ. FT.  
3.044 ACRES

LOT 6  
105,333 SQ. FT.  
2.418 ACRES

LOT 7  
89,926 SQ. FT.  
2.064 ACRES

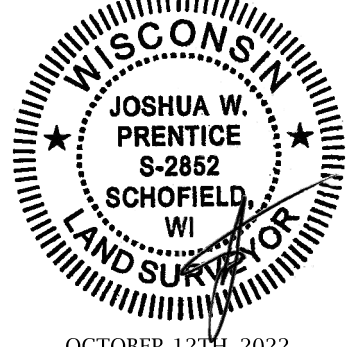

LEGEND	
▲	PK NAIL FOUND
○	DRILL HOLE FOUND
×	CHISELED "X" FOUND
□	1-1/4 IN. O.D. IRON PIPE FOUND
○	SET DRILL HOLE
(126.00')	RECORDED BEARING/LENGTH
126.00'	MEASURED BEARING/LENGTH
---	EXISTING BUILDING LINE

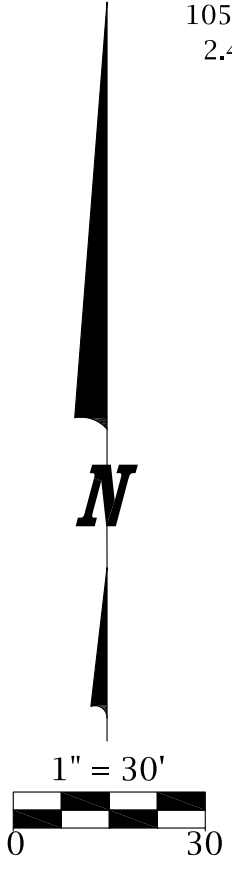

DATE	REVISION	BY	CHK'D
10/12/2022	REVISED PER COMMENTS	JLR	JWP

REI Engineering, Inc.  
1000 N. 20TH AVENUE  
WAUSAU, WISCONSIN 54401  
PHONE: 765.833.3386 FAX: 765.833.4266  
EMAIL: MAIL@REIENGINEERING.COM

MUNICIPAL PLAT OF  
**ALEXANDER DAVIS PLAT**

ALL OF LOT 1 OF CERTIFIED SURVEY MAP NUMBER 17778, RECORDED IN VOLUME 86, ON PAGE 23, AS DOCUMENT NUMBER 1740752 AND PART OF CERTIFIED SURVEY MAP NUMBER 2264, RECORDED IN VOLUME 9, ON PAGE 48, AS DOCUMENT NUMBER 756295, BOTH FILED IN THE MARATHON COUNTY REGISTER OF DEEDS OFFICE; ALSO KNOWN AS BLOCKS 9, 10, 11, 12, 19, 20, 23, AND 24 OF THE ORIGINAL PLAT OF THE CITY OF WAUSAU, VACATED JACKSON STREET, VACATED WASHINGTON STREET, VACATED SECOND STREET, VACATED THIRD STREET, AND VACATED FOURTH STREET; ALL LOCATED IN GOVERNMENT LOT 5 OF SECTION 35 AND GOVERNMENT LOT 1 OF SECTION 36, TOWNSHIP 29 NORTH, RANGE 7 EAST, CITY OF WAUSAU, MARATHON COUNTY, WISCONSIN.

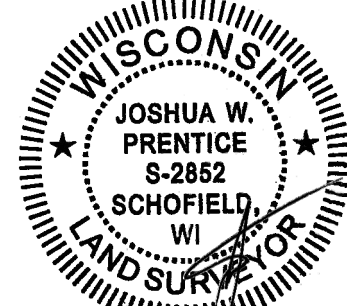

OCTOBER 12TH, 2022

**LIMITED LIABILITY COMPANY OWNER'S CERTIFICATE OF DEDICATION**

WAUSAU OPPORTUNITY ZONE, LLC, A WISCONSIN LIMITED LIABILITY COMPANY, AS OWNER, DOES HEREBY CERTIFY THAT SAID COMPANY CAUSED THE LAND DESCRIBED ON THE ALEXANDER DAVIS PLAT TO BE SURVEYED, DIVIDED, MAPPED AND DEDICATED, AS REPRESENTED ON THIS ALEXANDER DAVIS PLAT.

WAUSAU OPPORTUNITY ZONE, LLC, DOES FURTHER CERTIFY THAT THIS PLAT IS REQUIRED BY S.236.10 OR S.236.12 TO BE SUBMITTED TO THE FOLLOWING FOR APPROVAL OR OBJECTION: CITY OF WAUSAU AND THE STATE OF WISCONSIN DEPT. OF ADMINISTRATION.

IN WITNESS WHEREOF, THE SAID WAUSAU OPPORTUNITY ZONE, LLC, HAS CAUSED THESE PRESENTS

TO BE SIGNED BY \_\_\_\_\_, MEMBER AT \_\_\_\_\_, WISCONSIN,

THIS \_\_\_\_\_ DAY OF \_\_\_\_\_, 2022

IN THE PRESENCE OF: WAUSAU OPPORTUNITY ZONE, LLC

\_\_\_\_\_

\_\_\_\_\_, MEMBER

STATE OF WISCONSIN )  
 ) SS  
 \_\_\_\_\_ COUNTY)

PERSONALLY CAME BEFORE ME THIS \_\_\_\_\_ DAY OF \_\_\_\_\_, 2022 THE ABOVE NAMED

\_\_\_\_\_, MEMBER OF THE ABOVE NAMED WAUSAU OPPORTUNITY ZONE, LLC AND TO ME KNOWN TO BE THE SAME PERSONS WHO EXECUTED THE FOREGOING LIMITED LIABILITY COMPANY OWNER'S CERTIFICATE OF DEDICATION AND TO ME KNOWN TO BE SUCH MEMBER OF SAID COMPANY, AND ACKNOWLEDGE THAT THEY EXECUTED THE FOREGOING LIMITED LIABILITY COMPANY OWNER'S CERTIFICATE OF DEDICATION AS SUCH MEMBER AS THE DEED OF SAID COMPANY, BY ITS AUTHORITY.

NOTARY PUBLIC STATE OF WISCONSIN

MY COMMISSION EXPIRES \_\_\_\_\_

**OWNER'S CERTIFICATE OF DEDICATION**

CITY OF WAUSAU, AS OWNER, DOES HEREBY CERTIFY THAT THEY CAUSED THE LAND DESCRIBED ON THE ALEXANDER DAVIS PLAT TO BE SURVEYED, DIVIDED, MAPPED, AND DEDICATED, AS REPRESENTED ON THIS ALEXANDER DAVIS PLAT.

CITY OF WAUSAU DOES FURTHER CERTIFY THAT THIS PLAT IS REQUIRED BY S. 236.10 OR S. 236.12 TO BE SUBMITTED TO THE FOLLOWING FOR APPROVAL OR OBJECTION: CITY OF WAUSAU AND THE WISCONSIN DEPARTMENT OF ADMINISTRATION.

IN WITNESS WHEREOF, CITY OF WAUSAU, HAS CAUSED THESE PRESENTS

TO BE SIGNED BY (PRINT NAME) \_\_\_\_\_, (TITLE) \_\_\_\_\_

AND COUNTERSIGNED BY (PRINT NAME) \_\_\_\_\_, (TITLE) \_\_\_\_\_,

AT \_\_\_\_\_, WISCONSIN, THIS \_\_\_\_\_ DAY OF \_\_\_\_\_, 2022.

IN THE PRESENCE OF: CITY OF WAUSAU

(SIGNATURE) \_\_\_\_\_

(PRINT NAME) \_\_\_\_\_

SIGNATURE \_\_\_\_\_

(PRINT NAME) \_\_\_\_\_

STATE OF WISCONSIN )

) SS

\_\_\_\_\_ COUNTY)

PERSONALLY CAME BEFORE ME THIS \_\_\_\_\_ DAY OF \_\_\_\_\_, 2022,

THE ABOVE NAMED (PRINT NAME) \_\_\_\_\_, (TITLE) \_\_\_\_\_

AND (PRINT NAME) \_\_\_\_\_, (TITLE) \_\_\_\_\_,

OF THE ABOVE NAMED TO ME KNOWN TO BE THE SAME PERSONS WHO EXECUTED THE FOREGOING INSTRUMENT AND TO ME KNOWN TO BE SUCH OFFICERS OF SAID CITY OF WAUSAU, AND ACKNOWLEDGE THAT THEY EXECUTED THE FOREGOING INSTRUMENT AS SUCH OFFICERS AS THE DEED OF SAID CITY OF WAUSAU, BY ITS AUTHORITY.

NOTARY PUBLIC STATE OF WISCONSIN

MY COMMISSION EXPIRES \_\_\_\_\_

**LESSEE'S CERTIFICATE**

HOM FURNITURE, INC., A CORPORATION FORMED UNDER AND BY VIRTUE OF THE LAWS OF THE STATE OF MINNESOTA, HAVING AN INTEREST IN THESE LANDS, DOES HEREBY CERTIFY THAT SAID CORPORATION CAUSED THE LAND DESCRIBED ON THIS ALEXANDER DAVIS PLAT TO BE SURVEYED, DIVIDED, MAPPED, AND DEDICATED AS REPRESENTED ON THIS ALEXANDER DAVIS PLAT.

IN WITNESS WHEREOF, THE SAID HOM FURNITURE, INC. HAS CAUSED THESE PRESENTS TO BE SIGNED BY

\_\_\_\_\_, AT \_\_\_\_\_, AND ITS CORPORATE SEAL

HEREUNTO AFFIXED ON THIS \_\_\_\_\_ DAY OF \_\_\_\_\_ 2\_\_\_\_. IN THE PRESENCE OF: HOM FURNITURE, INC.

\_\_\_\_\_, TITLE

STATE OF \_\_\_\_\_)

) SS

\_\_\_\_\_ COUNTY)

PERSONALLY CAME BEFORE ME THIS \_\_\_\_\_ DAY OF \_\_\_\_\_, 2022, THE

ABOVE NAMED \_\_\_\_\_

OF THE ABOVE NAMED CORPORATION TO ME KNOWN TO BE THE SAME PERSONS WHO EXECUTED THE FOREGOING INSTRUMENT AND TO ME KNOWN TO BE SUCH OFFICER OF SAID CORPORATION, AND ACKNOWLEDGE THAT THEY EXECUTED THE FOREGOING INSTRUMENT AS SUCH OFFICER AS THE DEED OF SAID CORPORATION, BY ITS AUTHORITY.

\_\_\_\_\_, NOTARY PUBLIC

STATE OF WISCONSIN

MY COMMISSION EXPIRES \_\_\_\_\_

**CERTIFICATE OF THE CITY OF WAUSAU TREASURER**

STATE OF WISCONSIN )

) SS

MARATHON COUNTY)

I, MARYANNE GROAT, BEING THE DULY APPOINTED, QUALIFIED AND ACTING TREASURER OF THE CITY OF WAUSAU, WISCONSIN, DO HEREBY CERTIFY THAT THE RECORDS IN MY OFFICE SHOW NO UNPAID TAXES OR UNPAID SPECIAL ASSESSMENTS AS OF

\_\_\_\_\_, 2022 AFFECTING THE LANDS INCLUDED IN THE ALEXANDER DAVIS PLAT.

DATED THIS \_\_\_\_\_ DAY OF \_\_\_\_\_, 2022

\_\_\_\_\_, TREASURER

**CITY OF WAUSAU COMMON COUNCIL APPROVAL CERTIFICATE:**

RESOLVED, THAT THE ALEXANDER DAVIS PLAT, IN THE CITY OF WAUSAU, WAUSAU OPPORTUNITY ZONE, LLC, AND CITY OF WAUSAU, OWNERS, IS HEREBY APPROVED BY THE CITY OF WAUSAU COMMON COUNCIL.

DATE \_\_\_\_\_ APPROVED \_\_\_\_\_

\_\_\_\_\_ MAYOR

DATE \_\_\_\_\_ SIGNED \_\_\_\_\_

\_\_\_\_\_ MAYOR

I HEREBY CERTIFY THAT THE AFOREMENTIONED ALEXANDER DAVIS PLAT HAS BEEN APPROVED BY THE CITY OF WAUSAU COMMON COUNCIL.

\_\_\_\_\_, CITY OF WAUSAU CLERK

**MARATHON COUNTY TREASURER'S CERTIFICATE**

STATE OF WISCONSIN )

) SS

MARATHON COUNTY)

I, CONNIE BEYERSDORFF, COUNTY TREASURER, BEING THE DULY ELECTED, QUALIFIED, AND ACTING TREASURER OF THE COUNTY OF MARATHON, DO HEREBY CERTIFY THAT THE RECORDS IN MY OFFICE SHOW NO UNREDEEMED TAX SALES AND NO UNPAID TAXES OR SPECIAL ASSESSMENTS AS OF

\_\_\_\_\_, 2022, AFFECTING THE LANDS INCLUDED IN THE ALEXANDER DAVIS PLAT.

DATED THIS \_\_\_\_\_ DAY OF \_\_\_\_\_, 2022

\_\_\_\_\_, TREASURER, MARATHON COUNTY

DATE	REVISION	BY	CHK'D
10/12/2022	REVISED PER COMMENTS	JLR	JWP

REI Engineering, Inc.  
1401 N. 27TH AVENUE  
WAUSAU, WISCONSIN 54405  
PHONE: 715.875.0750 FAX: 715.875.0560  
EMAIL: MAIL@REIENGINEERING.COM

CIVIL & ENVIRONMENTAL  
ENGINEERING, SURVEYING

**ATTACHMENT C**



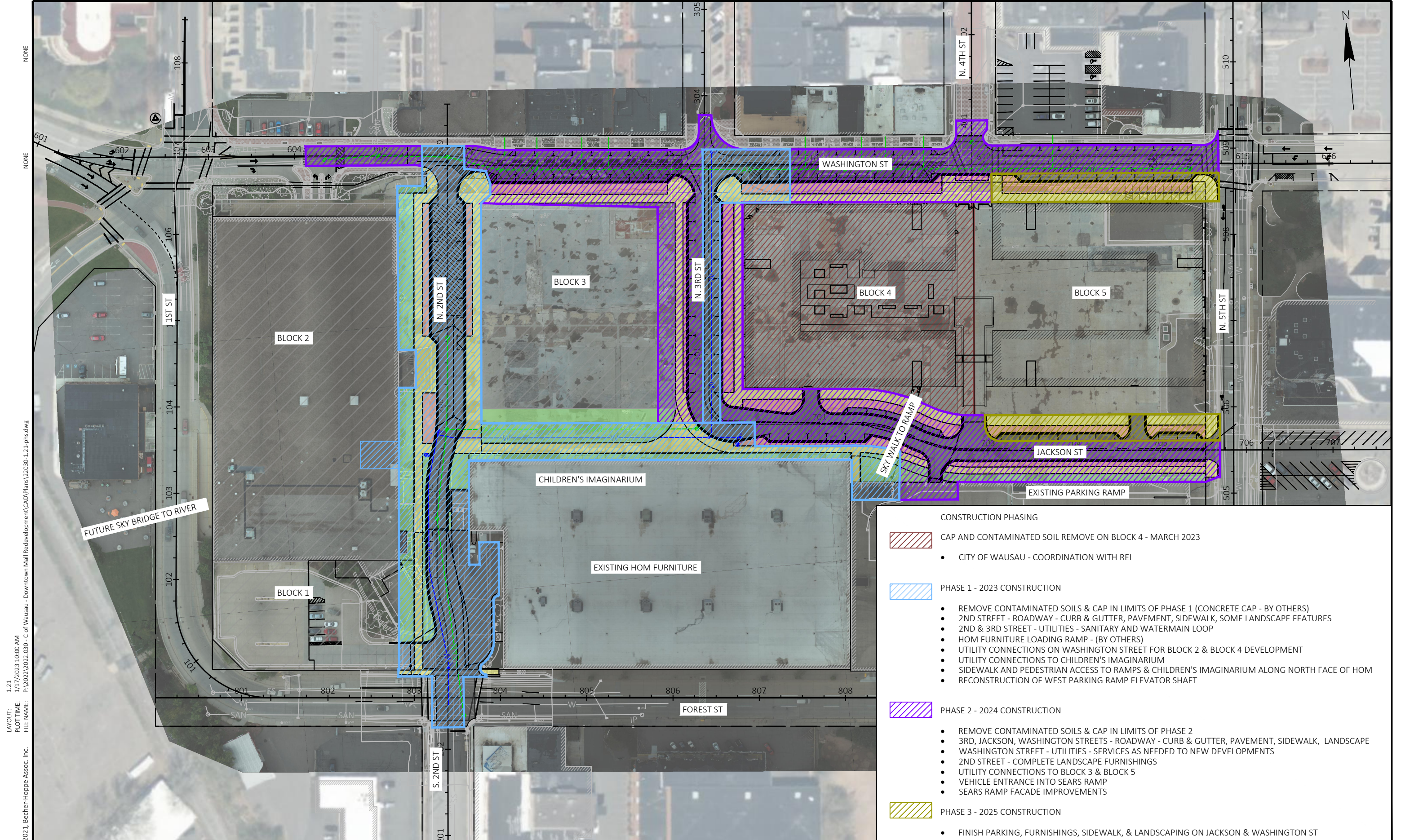

**STREET REDEVELOPMENT PLANS**





FUTURE SKY BRIDGE TO RIVER

SKY WALK TO RAMP

- CONSTRUCTION PHASING**
-  CAP AND CONTAMINATED SOIL REMOVE ON BLOCK 4 - MARCH 2023
    - CITY OF WAUSAU - COORDINATION WITH REI
  -  PHASE 1 - 2023 CONSTRUCTION
    - REMOVE CONTAMINATED SOILS & CAP IN LIMITS OF PHASE 1 (CONCRETE CAP - BY OTHERS)
    - 2ND STREET - ROADWAY - CURB & GUTTER, PAVEMENT, SIDEWALK, SOME LANDSCAPE FEATURES
    - 2ND & 3RD STREET - UTILITIES - SANITARY AND WATERMAIN LOOP
    - HOM FURNITURE LOADING RAMP - (BY OTHERS)
    - UTILITY CONNECTIONS ON WASHINGTON STREET FOR BLOCK 2 & BLOCK 4 DEVELOPMENT
    - UTILITY CONNECTIONS TO CHILDREN'S IMAGINARIUM
    - SIDEWALK AND PEDESTRIAN ACCESS TO RAMPS & CHILDREN'S IMAGINARIUM ALONG NORTH FACE OF HOM
    - RECONSTRUCTION OF WEST PARKING RAMP ELEVATOR SHAFT
  -  PHASE 2 - 2024 CONSTRUCTION
    - REMOVE CONTAMINATED SOILS & CAP IN LIMITS OF PHASE 2
    - 3RD, JACKSON, WASHINGTON STREETS - ROADWAY - CURB & GUTTER, PAVEMENT, SIDEWALK, LANDSCAPE
    - WASHINGTON STREET - UTILITIES - SERVICES AS NEEDED TO NEW DEVELOPMENTS
    - 2ND STREET - COMPLETE LANDSCAPE FURNISHINGS
    - UTILITY CONNECTIONS TO BLOCK 3 & BLOCK 5
    - VEHICLE ENTRANCE INTO SEARS RAMP
    - SEARS RAMP FACADE IMPROVEMENTS
  -  PHASE 3 - 2025 CONSTRUCTION
    - FINISH PARKING, FURNISHINGS, SIDEWALK, & LANDSCAPING ON JACKSON & WASHINGTON ST

LAYOUT: 1.21  
 PLOT TIME: 1/17/2023 10:00 AM  
 FILE NAME: P:\2022\2022.030 - C of Wausau - Downtown Mall Redevelopment\CAD\Plans\22.030-1.21-phs.dwg  
 Copyright 2021, Becher-Hoppe Assoc. Inc.

**ATTACHMENT D**

**PROPOSED CONCRETE REMOVAL AREAS FOR RE-  
DEVELOPMENT**



LEGEND  
 ✕ ✕ ✕  
 SAWCUT LINE

FOUNDATION WALL TO REMAIN.  
 REMOVE UNDER CITY STREET  
 CONSTRUCTION SCHEDULE.

PHASE 2 CONCRETE REMOVAL  
 8,630 SQ. FT.

Contaminated Soil Limits

ACCESS TO EASTBOUND WASHINGTON ST. IS  
 AVAILABLE FROM FORMER SEARS ENTRANCE

RIGHT-OF-WAY

RIGHT-OF-WAY

WASHINGTON STREET

Clean Soil

CONSTRUCTION  
 ENTRANCE/EXIT

LOT 4

LOT 5

PHASE I CONCRETE REMOVAL  
 192,000 SQ. FT.

Contaminated Soil

CONSTRUCTION ENTRANCE/EXIT  
 CITY STREET IMPROVEMENT PROJECT

LOT 3

PHASE 2 CONCRETE REMOVAL  
 17,010 SQ. FT.

LOT 6

PHASE 3 CONCRETE REMOVAL  
 7,890 SQ. FT.

FOREST STREET

SOUTH 2ND STREET

SOUTH 4TH STREET

SOUTH 5TH STREET

Exhibit B

DRAWING FILE: P:\19400-94099\19485E - WAUSAU MALL\DRAWINGS\19485E-WOZ CONCRETE REMOVAL.DWG LAYOUT: C200  
 PLOTTED: JAN 23, 2023 - 2:45PM PLOTTED BY: LOGANZ

REI Engineering, INC.  
 4080 N. 20TH AVENUE  
 WAUSAU, WISCONSIN 54401  
 PHONE: 715.675.9784, FAX: 715.675.4060  
 EMAIL: MAIL@REIENGINEERING.COM



CIVIL & ENVIRONMENTAL  
 ENGINEERING, SURVEYING

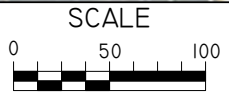

DATE	REVISION	BY	CHKD	SURVEYED BY:	DESIGNED BY:	SURVEY DATE:
				SURVEY CHKD BY: <td>CIVIL CHKD BY: <td>CIVIL DATE: 01/19/23</td> </td>	CIVIL CHKD BY: <td>CIVIL DATE: 01/19/23</td>	CIVIL DATE: 01/19/23
				SURVEY APVD BY: <td>CIVIL APVD BY: <td>DRAWN BY: LAZ</td> </td>	CIVIL APVD BY: <td>DRAWN BY: LAZ</td>	DRAWN BY: LAZ

WOZ CONCRETE REMOVAL  
 FORMER WAUSAU MALL  
 301 WASHINGTON ST  
 WAUSAU, WI

REI  
 REI No. 9485E  
 SHEET C200

**ATTACHMENT E**

**EROSION CONTROL PLAN**



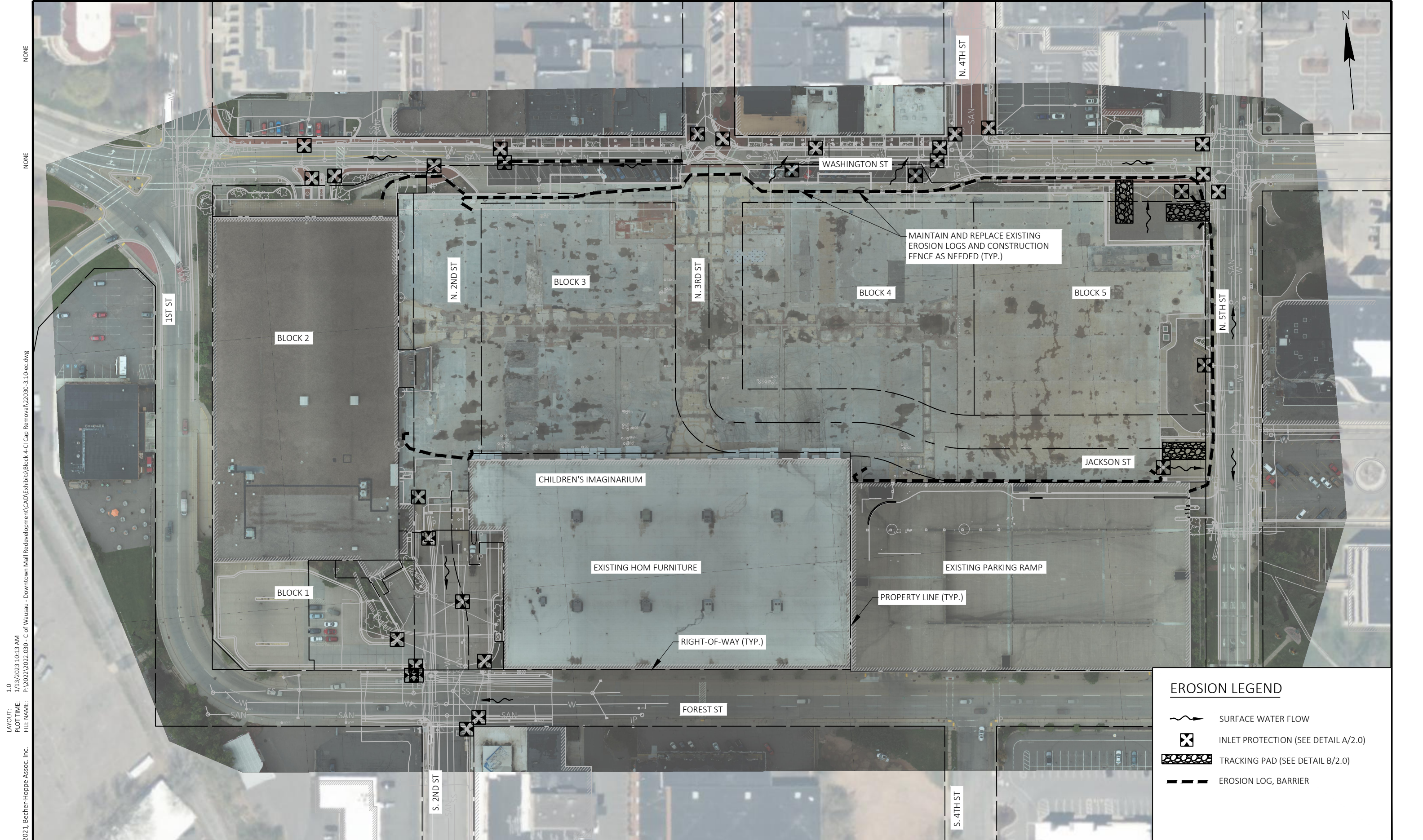

LAYOUT: 1.0  
 PLOT TIME: 1/13/2023 10:13 AM  
 FILE NAME: P:\2022\2022.030 - C of Wausau - Downtown Mall Redevelopment\CAD\Exhibits\Block 4-Cl Cap Removal\22030-3.10.ec.dwg  
 Copyright © 2021, Becher-Hoppe Assoc. Inc.

EROSION LEGEND	
	SURFACE WATER FLOW
	INLET PROTECTION (SEE DETAIL A/2.0)
	TRACKING PAD (SEE DETAIL B/2.0)
	EROSION LOG, BARRIER



330 N. 4th STREET  
 WAUSAU, WI 54403 • 715.845.8000  
 becherhoppe.com

DRAWN BY: MWO  
 CHECKED BY: BHA  
 DATE: 1/12/2023

PROJECT NO: 2022.030  
 REV. DATES:

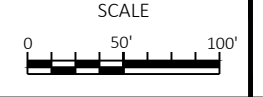

CITY OF WAUSAU  
 DOWNTOWN MALL REDEVELOPMENT

EROSION CONTROL PLAN  
 PARTIAL CAP REMOVAL

SHEET  
 1.0



LAYOUT: 2.00  
 PLOT TIME: 1/13/2023 10:14 AM  
 FILE NAME: P:\2022\2022.030 - C of Wausau - Downtown Mall Redevelopment\CAD\Exhibits\Block 4 - CI Cap Removal\22030-2.00-cd.dwg

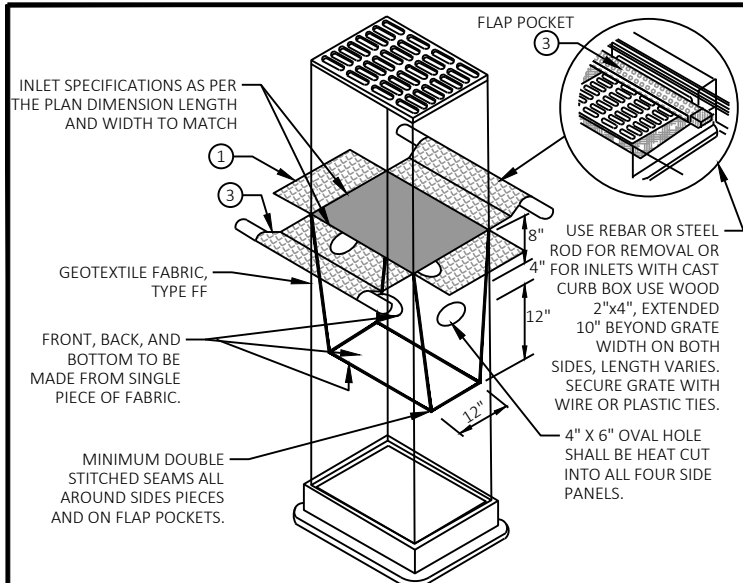

**A**  
 INLET PROTECTION TYPE D  
 2.00 NOT TO SCALE

- ① FINISHED SIZE, INCLUDING FLAP POCKETS WHERE REQUIRED, SHALL EXTEND A MINIMUM OF 10" AROUND THE PERIMETER TO FACILITATE MAINTENANCE OR REMOVAL.
- ② FOR INLET PROTECTION, TYPE C (WITH CURB BOX), AN ADDITIONAL 18" OF FABRIC IS WRAPPED AROUND THE WOOD AND SECURED WITH STAPLES. THE WOOD SHALL NOT BLOCK THE ENTIRE HEIGHT OF THE CURB BOX OPENING.
- ③ FLAP POCKETS SHALL BE LARGE ENOUGH TO ACCEPT WOOD 2X4.

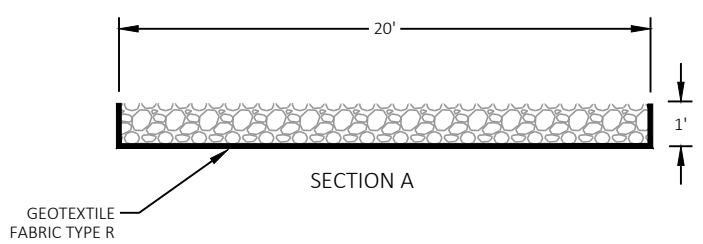
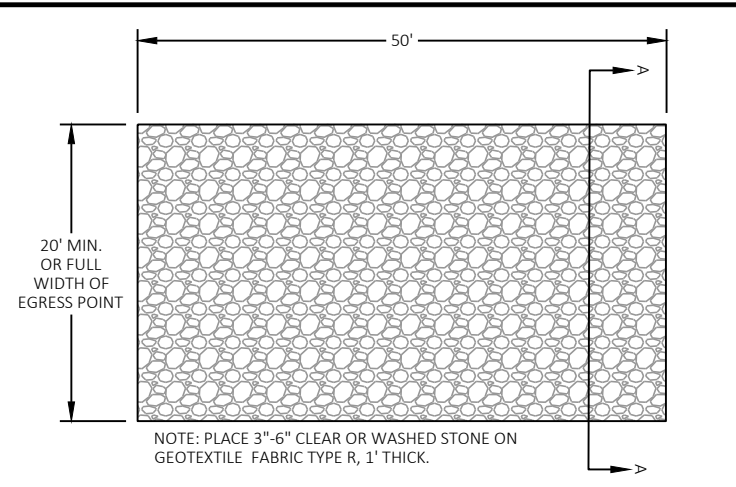

**B**  
 TRACK PAD  
 2.00 NOT TO SCALE

INSTALL AND MAINTAIN IN ACCORDANCE WITH W/DNR CONSERVATION PRACTICE STANDARD 1057.